

KAWAI

DIGITAL PIANO CN301 Owner's Manual

Important Information

Preparation

Basic Operation



Adjustments & Settings

Appendix

EN

Règles de sécurité (Supplémentaires pour le Canada)

CONSERVEZ CES INSTRUCTIONS

	CAUTION RISK OF ELECTRIC SHOCK DO NOT OPEN		AVERTISSEMENT POUR REDUIRE LES RISQUES D'INCENDIE OU D'ELECTROCUTION, PROTEGEZ CET APPAREIL DE LA PLUIE OU DE L'HUMIDITE.
---	---	---	---

AVIS : RISQUE DE CHOC ELECTRIQUE - NE PAS OUVRIR.

POUR REDUIRE LES RISQUES D'INCENDIE OU D'ELECTROCUTION, NE DEMONTEZ PAS LE COUVERCLE (OU L'ARRIERE). A L'INTERIEUR, AUCUNE PARTIE N'EST REPARABLE PAR L'UTILISATEUR. POUR LA MAINTENANCE, ADRESSEZ-VOUS A DU PERSONNEL QUALIFIE.





Le symbole de l'éclair avec une pointe de flèche à l'intérieur d'un triangle équilatéral met en garde l'utilisateur contre la présence de tension dangereuse, non isolée, à l'intérieur de l'appareil, dont l'amplitude peut être suffisante pour induire un risque d'électrocution d'une personne.



Le point d'exclamation à l'intérieur d'un triangle équilatéral alerte l'utilisateur de la présence de règles d'utilisation et d'entretien importantes dans la notice qui accompagne l'appareil.

Exemples de symboles graphiques

	Indique que des précautions doivent être prises. L'exemple indique à l'utilisateur qu'il doit faire attention à ne pas se faire coincer les doigts.
	Indique une manipulation interdite. L'exemple indique que le démontage de l'appareil est interdit.
	Indique qu'une manipulation doit être effectuée. L'exemple indique à l'utilisateur qu'il doit débrancher le câble d'alimentation de la prise secteur.

AVERTISSEMENT

Indique un risque potentiel qui peut entraîner la mort, ou de graves lésions, si l'appareil n'est pas manipulé correctement.

<p>Faite attention de ne pas introduire un produit étranger à l'intérieur de l'appareil.</p>		<p>L'introduction d'eau, d'aiguilles ou d'épingles à cheveux, peut provoquer une panne ou un court-circuit. Ce produit doit être mis à l'abri des écoulements ou projections d'eau. Ne jamais placer sur le produit des objets contenant des liquides, tels que des vases ou autres récipients.</p>
--	---	---

<p>Ce produit n'est pas totalement déconnecté du circuit électrique lorsqu'il est mis hors tension par le bouton d'arrêt. Si l'appareil ne doit pas être utilisé pendant une longue période, débranchez le câble d'alimentation de la prise secteur.</p>		<ul style="list-style-type: none"> ● Si vous ne le faisiez pas la foudre pourrait provoquer un incendie. ● Si vous ne le faisiez pas, la surchauffe de l'appareil pourrait provoquer un incendie.
--	---	---

Il est recommandé de placer l'instrument à proximité de la prise de courant et de positionner le câble d'alimentation secteur de sorte qu'il puisse être débranché rapidement en cas d'urgence, le courant électrique étant toujours présent tant que la prise est branchée même si le bouton de mise en marche est en position Arrêt.

[Seuls les produits avec 3P fiche]

INSTRUCTIONS DE MISE À LA TERRE

Ce produit doit être mis à la terre. En cas de défaillance matérielle ou de panne, la mise à la terre fournit un chemin de moindre résistance au courant électrique afin de réduire le risque d'électrocution. Ce produit est équipé d'un câble avec un conducteur de protection et une fiche de mise à la terre. La fiche doit être branchée dans une prise appropriée correctement installée et mise à la terre conformément à tous les codes et règlements locaux.

DANGER - La connexion incorrecte du conducteur de protection peut présenter un risque d'électrocution. Consultez un électricien ou un réparateur qualifié si vous avez des doutes en ce qui concerne la mise à la terre du produit. Ne modifiez pas la fiche fournie avec le produit – si elle n'est pas adaptée à la prise, faites installer une prise correcte par un électricien qualifié.

PRECAUTION

Indique un risque potentiel qui peut entraîner la détérioration, ou des dommages, pour l'appareil ou ses propriétés, si celui-ci n'est pas manipulé correctement.

Description de la l'emplacement de la référence (Le cas échéant):
 Anglais phrase: The nameplate label is located on the underside of the instruments, as indicated below.
 Français phrase: La référence commerciale est inscrite sur une étiquette en dessous de votre instrument, conformément à l'indication ci-dessous.

Votre piano doit être placé à un endroit tel que sa position n'altère pas sa propre ventilation. Gardez une distance minimum de 5 cm autour de l'instrument pour une aération suffisante.

Important Safety Instructions

SAVE THESE INSTRUCTIONS

INSTRUCTIONS PERTAINING TO A RISK OF FIRE, ELECTRIC SHOCK, OR INJURY TO PERSONS



WARNING

TO REDUCE THE RISK OF FIRE OR ELECTRIC SHOCK, DO NOT EXPOSE THIS PRODUCT TO RAIN OR MOISTURE.

AVIS : RISQUE DE CHOC ELECTRIQUE - NE PAS OUVRIR.

TO REDUCE THE RISK OF ELECTRIC SHOCK, DO NOT OPEN THE AC ADAPTOR.
NO USER-SERVICEABLE PARTS INSIDE. REFER SERVICING TO QUALIFIED SERVICE PERSONNEL.



The lightning flash with arrowhead symbol, within an equilateral triangle, is intended to alert the user to the presence of uninsulated "dangerous voltage" within the product's enclosure that may be of sufficient magnitude to constitute a risk of electric shock to persons.



The exclamation point within an equilateral triangle is intended to alert the user to the presence of important operating and maintenance (servicing) instructions in the literature accompanying the product.

Examples of Picture Symbols



denotes that care should be taken.
The example instructs the user to take care not to allow fingers to be trapped.



denotes a prohibited operation.
The example instructs that disassembly of the product is prohibited.



denotes an operation that should be carried out.
The example instructs the user to remove the power cord plug from the AC outlet.

Read all the instructions before using the product.

- 1) Read these instructions.
- 2) Keep these instructions.
- 3) Heed all warnings.
- 4) Follow all instructions.
- 5) Do not use this apparatus near water.
- 6) Clean only with dry cloth.
- 7) Do not block any ventilation openings. Install in accordance with the manufacturer's instructions.
- 8) Do not install near any heat sources such as radiators, heat registers, stoves, or other apparatus (including amplifiers) that produce heat.
- 9) Do not defeat the safety purpose of the polarized or grounding-type plug. A polarized plug has two blades with one wider than the other. A grounding type plug has two blades and a third grounding prong. The wide blade or the third prongs are provided for your safety. If the provided plug does not fit into your outlet, consult an electrician for replacement of the obsolete outlet.
- 10) Protect the power cord from being walked on or pinched particularly at plugs, convenience receptacles, and the point where they exit from the apparatus.
- 11) Only use attachments/accessories specified by the manufacturer.
- 12) Use only with the cart, stand, tripod, bracket, or table specified by the manufacturer, or sold with the apparatus. When a cart is used, use caution when moving the cart/apparatus combination to avoid injury from tip-over. 
- 13) Unplug this apparatus during lightning storms or when unused for long periods of time.
- 14) Refer all servicing to qualified service personnel. Servicing is required when the apparatus has been damaged in any way, such as power-supply cord or plug is damaged, liquid has been spilled or object have fallen into the apparatus, the apparatus has been exposed to rain or moisture, does not operate normally, or has been dropped.

WARNING - When using electric products, basic precautions should always be followed, including the following.



WARNING

Indicates a potential hazard that could result in death or serious injury if the product is handled incorrectly.

The product should be connected to an AC outlet of the specified voltage.



- If you are going to use an AC power cord, make sure that its has the correct plug shape and conforms to the specified power voltage.
- Failure to do so may result in fire.

Do not insert or disconnect the power cord plug with wet hands.



Doing so may cause electric shock.

Take care not to allow any foreign matter to enter the product.



Entry of water, needles or hair pins may result in breakdown or short-circuit. The product shall not be exposed to dripping or splashing. No objects filled with liquids, such as vases, shall be placed on the product.

The chair must be used properly (it must be used only when playing the product).

- Do not play with it or stand on it.
- Only one person is allowed to sit on it.
- Do not sit on it when opening the lid.
- Re-tighten the bolts occasionally.

Doing so may cause the chair to fall over or your fingers to be trapped, resulting in injury.

When using the headphones, do not listen for long periods of time at high volume levels.

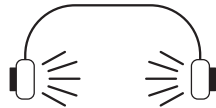

Doing so may result in hearing problems.

Do not lean against the keyboard.



Doing so may cause the product to fall over, resulting in injury.

Do not disassemble, repair or modify the product.



Doing so may result in product breakdown, electric shock or short-circuit.

When disconnecting the AC power cord's plug, always hold the plug and pull it to remove it.



- Pulling the AC power cord itself may damage the cord, causing a fire, electric shock or short-circuit.

The product is not completely disconnected from the power supply even when the power switch is turned off. If the product will not be used for a long time, unplug the AC power cord from the AC outlet.



- Failure to do so may cause fire in case of lightning.
- Failure to do so may over-heat the product, resulting in fire.

This product may be equipped with a polarized line plug (one blade wider than the other). This is a safety feature. If you are unable to insert the plug into the outlet, contact an electrician to replace your obsolete outlet. Do not defeat the safety purpose of the plug.



It is a good practice to have the instrument near the AC outlet and the power cord plug in a position so that it can readily be disconnected in an emergency because electricity is always charging while the plug is in the AC outlet even in a power switch off condition.



CAUTION

Indicates a potential hazard that could result in injury or damage to the product or other property if the product is handled incorrectly.

Do not use the product in the following areas.

- Areas, such as those near windows, where the product is exposed to direct sunlight
- Extremely hot areas, such as near a heater
- Extremely cold areas, such as outside
- Extremely humid areas
- Areas where a large amount of sand or dust is present
- Areas where the product is exposed to excessive vibrations

Using the product in such areas may result in product breakdown. Use the product only in moderate climates (not in tropical climates).

Use only the AC adaptor included with this instrument to power the instrument.

- Do not use other AC adaptors to power this instrument.
- Do not use the included AC adaptor or AC power cord to power other equipment.

When you close the keyboard cover, close it gently.



Closing it roughly may trap your fingers, resulting in injury.

Before connecting cords, make sure that the power to this product and other devices is turned OFF.

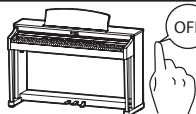

Failure to do so may cause breakdown of this product and other devices.

Do not drag the product on the floor. Take care not to drop the product.

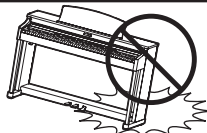

Please lift up the product when moving it. Please note that the product is heavy and must be carried by more than two persons. Dropping the product may result in breakdown.

Do not place the product near electrical appliances such as TVs and radios.

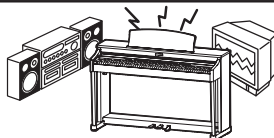

- Doing so may cause the product to generate noise.
- If the product generates noise, move the product sufficiently away from the electrical appliance or connect it to another AC outlet.

When connecting the AC power cord and other cords, take care not to get them tangled.



Failure to do so may damage them, resulting in fire, electric shock or short-circuit.

Do not wipe the product with benzene or thinner.



- Doing so may result in discoloration or deformation of the product.
- When cleaning the product, put a soft cloth in lukewarm water, squeeze it well, then wipe the product.

Do not stand on the product or exert excessive force.



- Doing so may cause the product to become deformed or fall over, resulting in breakdown or injury.

Do not place naked flame, such as lighted candles on the product.



Doing so may cause the illumination to fall over, resulting in fire.

Ensure that the ventilation is not impeded by covering the ventilation openings with items, such as newspaper, table-cloths, curtains, etc.

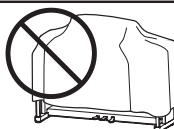

Failure to do so may over-heat the product, resulting in fire.

The product should be located so that its location or position does not interfere with its proper ventilation. Ensure a minimum distance of 5cm around the product for sufficient ventilation.

The product should be serviced by qualified service personnel when:

- **The power supply cord or the plug has been damaged.**
- **Objects have fallen, or liquid has been spilled into the product.**
- **The product has been exposed to rain.**
- **The product does not appear to operate normally or exhibits a marked change in performance.**
- **The product has been dropped, or the enclosure damaged.**

Notes on Repair

Should an abnormality occur in the product, immediately turn the power OFF, disconnect the power cord plug, and then contact the shop from which the product was purchased.

CAUTION:

To prevent electric shock, match wide blade of plug to wide slot, fully insert.

ATTENTION:

Pour éviter les chocs électriques, introduire la lame la plus large de la fiche dans la borne correspondante de la prise et pousser jusqu'au fond.



An information on Disposal for users

If your product is marked with this recycling symbol it means that, at the end of its life, you must dispose of it separately by taking it to an appropriate collection point.

You should not mix it with general household waste. Disposing of this product correctly will prevent potential negative effects on the environment and human health which could otherwise arise due to inappropriate waste handling.

For further details, please contact your local authority.
(European Union only)

Instruction for AC power cord (U.K.)

IMPORTANT

THE WIRES IN THIS MAINS LEAD ARE COLOURED IN ACCORDANCE WITH THE FOLLOWING CODE.

BLUE : NEUTRAL
BROWN : LIVE

As the colours of the wires in the mains lead of this apparatus may not correspond with the coloured markings identifying the terminals in your plug, proceed as follows:

The wire which is coloured BLUE must be connected to the terminal which is marked with the letter N or coloured BLACK.

The wire which is coloured BROWN must be connected to the terminal which is marked with the letter L or coloured RED.

Do not plug either terminal of the power cord to the the ground od AC outlet on the wall.

Canadian Radio Interference Regulations

This instrument complies with the limits for a class B digital apparatus, pursuant to the Radio Interference Regulations, C.R.C., c. 1374.

FCC Information (U.S.A)

CAUTION : Changes or modifications not expressly approved by the party responsible for compliance could void the user's authority to operate the equipment.

NOTE : This equipment has been tested and found to comply with the limits for a Class B digital device, pursuant to Part 15 of the FCC Rules. These limits are designed to provide reasonable protection against harmful interference in a residential installation. This equipment generates, uses and can radiate radio frequency energy and, if not installed and used in accordance with the instructions, may cause harmful interference to radio communications. However, there is no guarantee that interference will not occur in a particular installation. If this equipment does cause harmful interference to radio or television reception, which can be determined by turning the equipment off and on, the user is encouraged to try to correct the interference by one or more of the following measures:

- Reorient or relocate the receiving antenna.
- Increase the separation between the equipment and receiver.
- Connect the equipment into an outlet on a circuit different from that to which the receiver is connected.
- Consult the dealer or an experienced radio/TV technician for help.

Declaration of Conformity

Products : Electronic Piano
 Model Number : CN301
 Responsible Party Name : Kawai America Corporation
 Address : 2055 East University Drive Rancho Dominguez, CA 90220
 Telephone : 310-631-1771

This device complies with Part 15 of the FCC Rules.
 Operation is subject to the following two conditions:
 (1) this device may not cause harmful interference, and
 (2) this device must accept any interference received, including interference that may cause undesired operation.

The nameplate label is located on the underside of the instrument, as indicated below.

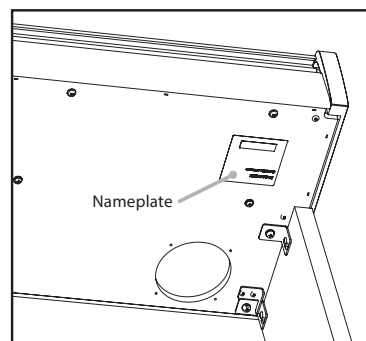

This applies only to products distributed by Kawai America Corporation.

Introduction

Thank you for purchasing this Kawai digital piano.

Please read this owner's manual carefully and keep the manual in a safe place to make full use of this product and maximise its product life.

About this owner's manual

This owner's manual contains quick references for basic playback features and operation details for various functions.

Nameplate

The information, including model name and serial number, is specified on the nameplate located on the underside of the instrument.







Intellectual property rights

- The **Bluetooth**® word mark and logos are registered trademarks owned by the Bluetooth SIG, Inc. and any use of such marks by Kawai Musical Instruments Mfg. Co., Ltd. is under license.
- "Windows" is a registered trademark of Microsoft Corporation.
- "Mac" is a registered trademark of Apple Inc.
- Some samples © PREMIER Engineering Inc.

Cleaning

- Use a dry soft cloth to wipe the main body.
- Avoid using alcohol, benzene, thinner, or chlorine bleach. Doing so may result in discoloration or deformation of the keys, exterior, or panels.
- Depending on the material of the cloth used, wiping the product repeatedly may result in discoloration or deformation.
- If the surface of the pedals become dirty, clean the pedals using a dry dish-washing sponge. Wiping the gold-plated pedals with a cloth may cause the surface to appear dull.
- If the pedals become dirty, do not attempt to clean them with rust-removing solvents, abrasives, or files.

Symbols

	The characters enclosed in brackets [] indicate the names of sliders, buttons, ports or jacks.
	This symbol shows the location of the button to be operated, and the number in this symbol indicates the order of operation. The value in this symbol corresponds to the number describing the operating instructions.
	The pointer finger symbol indicates key operation, and the value in this symbol corresponds to the number assigned to the corresponding operation.
	This symbol indicates operating precautions.
	This symbol describes terminology and provides additional information if the screen display is different from the name.
	This symbol indicates the page to be referenced.

About tuning

This piano is a digital instrument and does not require tuning. If any aspect of this instrument does not function or perform as expected, please contact the store from where the instrument was purchased to seek assistance.

Table of Contents

Important Information

Important Safety Instructions 2
 Introduction 7
 Table of Contents 8

Preparation

Part Names and Functions 10
 Opening/Closing the Key Cover 12
 Music Rest 12
 Pedal support bolt 12
 Power 13
 Home screen 13
 Volume and headphones 14

Basic Operation

Sounds..... 15
 Pedals 15
 Metronome 16
 Recorder 17
 Recording to internal memory
 and playing back 18
 Recording to a USB memory device
 and playing back 21
 Reverb 26
 Effects 27
 Dual 29
 Dual Settings 30
 Split 31
 Split Settings 32
 4 Hands 33
 Four Hands Settings 34
 Music Menu..... 35
 Demo Songs 35
 Piano Music 36
 Lesson 36
 Practicing 37
 Concert Magic 40
 Playing a Concert Magic song 40
 Listening to a Concert Magic song 40
 Concert Magic song settings 41

Registration Memories 42
 Panel Lock 45

Adjustments & Settings

Settings Menu 46
 Basic Settings..... 46
 1 Key Transpose..... 47
 2 Song Transpose 47
 3 Tone Control 48
 4 Speaker Volume 49
 5 Low Volume Balance 49
 6 Tuning 49
 7 Damper Hold 49
 10 Startup Settings 50
 11 Factory Reset 50
 12 Auto Display Off 50
 13 Auto Power Off 50
 Virtual Technician 51
 Smart Mode 51
 Advanced Mode 52
 Phones Settings..... 62
 1 Spatial Headphone Sound 62
 2 Phones Type 63
 3 Phones Volume 63
 USB Menu 63
 1 Load Song 66
 2 Load Registration All 67
 3 Load Registration Single 68
 4 Load Startup Setting 69
 5 Save Internal Song 70
 6 Save SMF Song 71
 7 Save Registration All 72
 8 Save Registration Single 73
 9 Save Startup Setting 74
 10 Rename File 75
 11 Delete File 76
 12 Format USB 76
 Bluetooth Settings 77
 1 Bluetooth 78
 2 Bluetooth Audio Volume 78

Appendix

Troubleshooting.....	79
Internal Songs List	81
Drum Rhythm List	83
Connecting to Other Devices	84
Assembly Instructions	86
Information about Adaptor Specifications ...	90
EU Declaration of Conformity	91
Specifications	92

For more information on MIDI and its operation details, please download the supplementary PDF manual from the Kawai Global website:

<https://www.kawai-global.com/support/manual>

Part Names and Functions

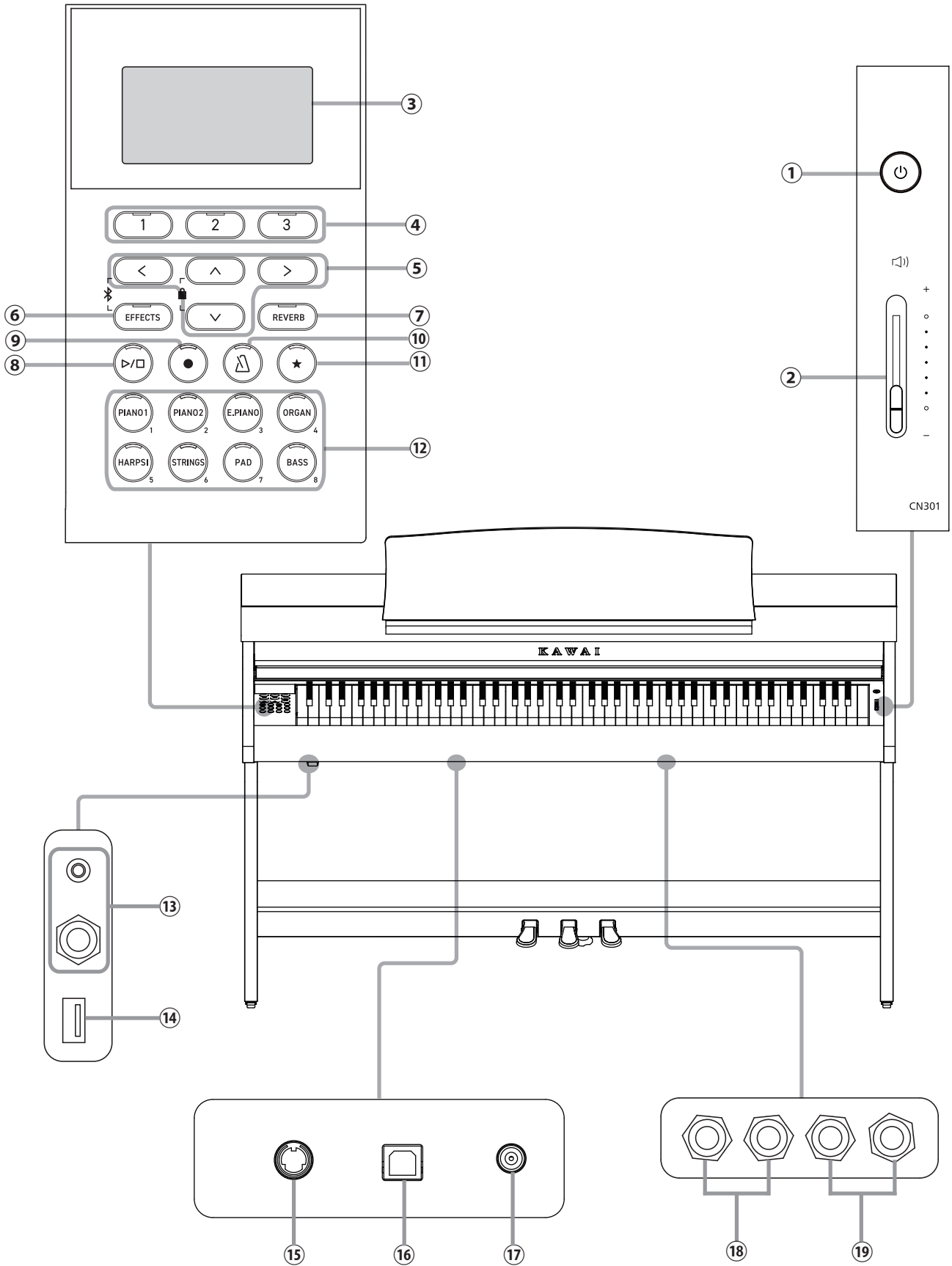

In market locations where Bluetooth functionality is not available, the Bluetooth mark will not be printed.

① [POWER] button

This button is used to turn the power on/off. Be sure to turn off the instrument after playing.

② [MASTER VOLUME] slider

This slider controls the volume output from the built-in speakers, headphones, or LINE OUT connectors.

③ Display

The display shows the function names and setting values.



A protective plastic film is attached to the display during production. Please remove this film before attempting to play the instrument.

④ [1][2][3] buttons

These buttons correspond to items displayed at the bottom of the display.

Their purposes vary depending on the displayed contents.

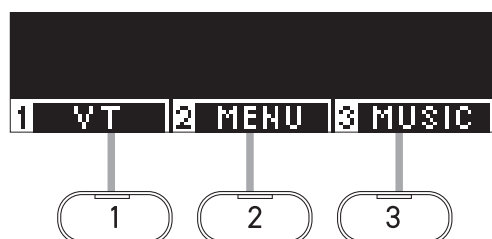
**⑤ ARROW buttons**

These buttons are used for various purposes such as displaying the previous screen or next screen.

They are [UP], [DOWN], [RIGHT], and [LEFT] buttons.

⑥ [EFFECTS] button

This button is used to select the effect, set how the effect is applied, and turn the effect on/off.

⑦ [REVERB] button

This button is used to select the reverb effect and turn the effect on/off.

⑧ [PLAY/STOP] button

This button is used to play/stop recorded performances and Internal Songs such as those stored in Lesson.

⑨ [REC] button

This button is used to record the performance.

⑩ [METRONOME] button

This button is used to turn the metronome function on/off and adjust its tempo, time signature, and volume settings.

⑪ [REGISTRATION] button

This button is used to store preferred sounds and settings to a Registration memory, where they can be quickly recalled.

⑫ SOUND buttons

These buttons are used to select the sound.

⑬ [PHONES] jacks

These jacks are used to connect stereo headphones to the instrument, allowing headphones with a stereo mini phone plug and headphones with a stereo standard plug to be connected at the same time.

⑭ [USB to DEVICE] port

This port is used to connect a USB memory device.

⑮ [PEDAL] connector

This connector is used to plug the pedal cable attached to the pedal unit.

⑯ [USB to HOST] port

This port is used to connect the instrument to a computer using a USB "B to A" type cable in order to send and receive MIDI data.

⑰ [DC IN] jack

This jack is used to connect the AC adaptor.

⑱ [LINE IN] jacks

These jacks are used to connect other electronic instruments or audio devices to output their sounds from the instrument's built-in speakers.

⑲ [LINE OUT] jacks

These jacks are used to connect other external devices (amplifier, stereo system) to listen to the instrument's sound, or to record to audio devices.

Opening/Closing the Key Cover

Opening the key cover

Gently lift the key cover with both hands, then slowly push it back into the instrument's body.



- Do not leave any object on the key cover when opening the key cover. Doing so could cause the objects to fall inside the instrument, leading to electric shock, short-circuit, ignition, or failure.
- Be careful not to have hands and fingers caught between the key cover and the main body.

Closing the key cover

Slowly pull the key cover with both hands, then gently lower it downward.

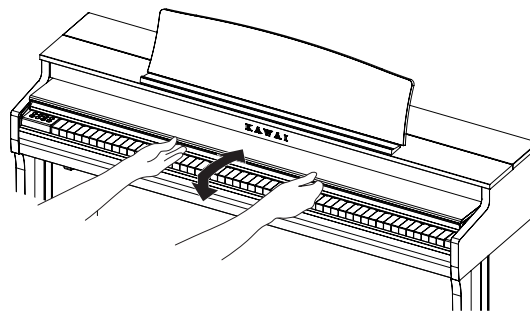

Music Rest

1. Lift the music rest.
2. Set the metal prop on the rear side of the music rest to a desired position in the recessed holder on the top surface of the main body.
(The angle is adjustable in three stages.)

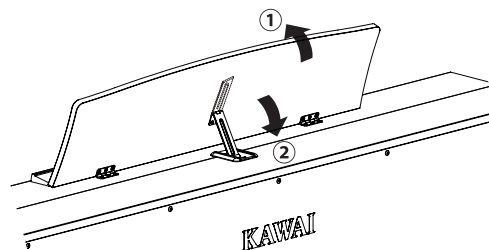

Pedal support bolt

A pedal support bolt is attached at the base of the pedal board to aid stability when the pedals are pushed.

Turn the bolt anti-clockwise until it makes contact with the floor and supports the pedals firmly. If the pedal support bolt does not make contact with the floor, the pedal board may become damaged.

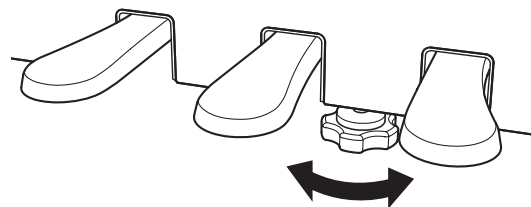

Power

1. Connecting the AC adaptor to the main body

Plug the supplied AC adaptor into the power cord and insert it into the [DC IN] jack located on the underside of the main body.

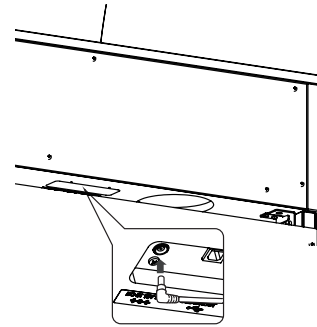

2. Connecting the plug into an outlet

Connect the AC power adaptor to an AC outlet.

3. Turning the power on/off

Press the [POWER] button to turn the power on.
When the instrument has started up, the LED indicator of the [POWER] button will turn on.

To turn the power off, press the [POWER] button again.

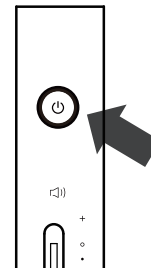

Do not turn off the power until the startup process is completed.
Do not unplug the power cord until the display has turned off.

Home screen

The first screen that appears when the instrument has started up after power-on is called the Home screen.
The Home screen is the initial menu of the operation.

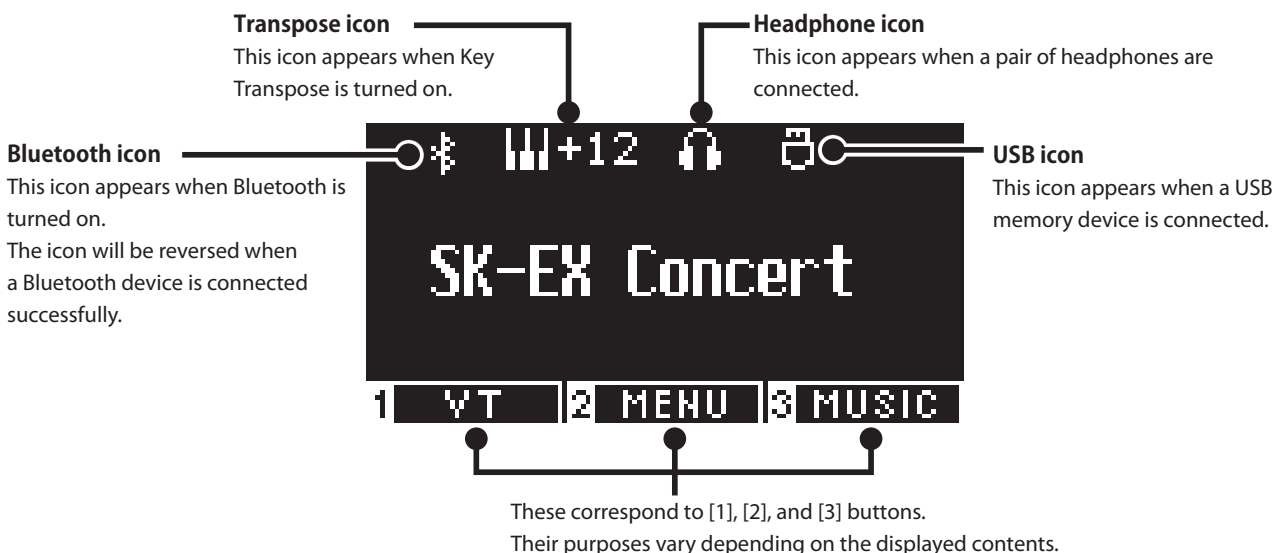

Volume and headphones

Adjusting the volume

Use the [MASTER VOLUME] slider located on the right side of the main body to adjust the volume.

Move the slider up to increase the volume and down to decrease the volume.

Adjust the volume while listening to the sound by striking the keys.

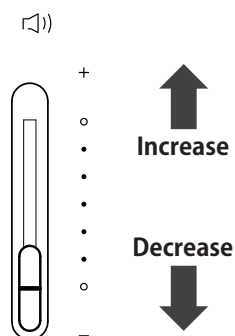

Using headphones

Plug the headphones into the [PHONES] jack located on the underside of the main body.

When the headphones are connected, the speakers on the main body no longer produce sound.

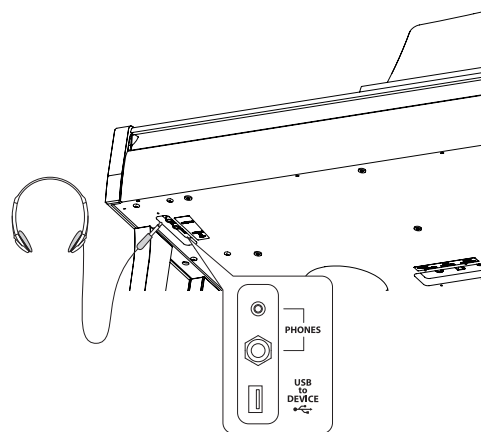

Using the headphone hook

When the headphones are not in use, the headphones can be placed on the headphone hook.

To use the headphone hook, attach it as shown in the illustration.



Do not hang any other items except headphones on the headphone hook. Doing so could result in damage.

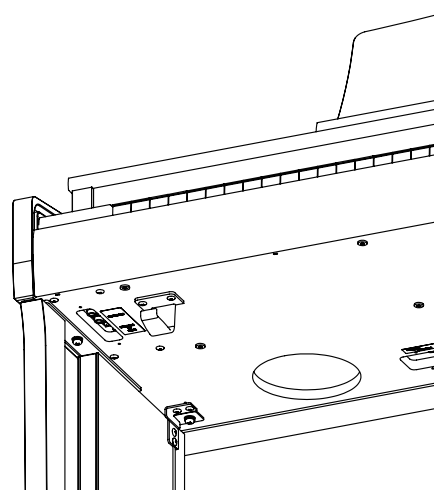

Sounds

This instrument features a selection of 45 realistic instrument sounds. Sounds are arranged into eight categories, with several sounds assigned to each SOUND button. “SK-EX Concert Grand Piano | Concert” is selected as the default setting. The sounds are displayed on the Home screen.

P81 Sound/Demo Songs List

Selecting a sound

- On the Home screen, press the [UP]/[DOWN] button to select a category.
Or, press the SOUND button to select the category.
The LED indicator for the selected SOUND button will turn on and the name of the selected sound will be shown in the LCD display.

 The display may show shortened sound names.

- Press the [LEFT]/[RIGHT] button to select a sound variation within the selected category.
Or, press the same SOUND button to select the variation.

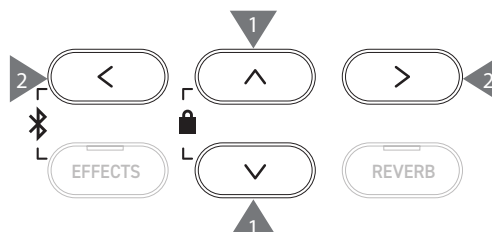

Pedals

This instrument is equipped with three pedals.

Damper pedal (right pedal)

Depressing this pedal while playing the piano will sustain the sound even after one's hands have been lifted from the keyboard. The length of reverberation can be controlled by the level of pedal depression. (Half-pedal supported)

Sostenuto pedal (centre pedal)

Depressing this pedal after pressing any key and before releasing the key(s) will sustain the sound of only those notes that have been played. Any keys that are subsequently pressed after stepping on the sostenuto pedal will not be sustained.

Soft pedal (left pedal)

Depressing this pedal softens the sound, reducing its volume slightly. The effect of the soft pedal can be controlled by the depressed depth of the pedal. Rotary speed (Slow or Fast) can be controlled when Rotary is selected as the Effect Type.

The effect of pressing each pedal may not be noticeable depending on the sound.

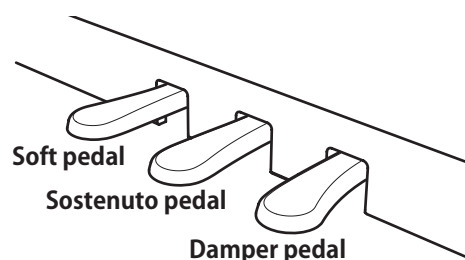

Grand Feel Pedal System

This instrument features the Grand Feel Pedal System, which replicates the sustain, soft, and sostenuto pedal weighting of a Shigeru Kawai SK-EX Concert Grand piano.

Metronome

The Metronome function provides a steady beat to aid practicing the piano.

Turning the Metronome on/off

- Press the [METRONOME] button.
The LED for the [METRONOME] button turns on and the metronome sound begins.
- Pressing the [METRONOME] button again will stop the metronome and turn off the LED indicator for the [METRONOME] button.



Metronome settings

Item	Description
Tempo	The value can be specified in the range from ♩ = 10 to 400. The default setting is ♩ = 120.
Beat/Rhythm	The beat setting is available from the following: 1/4, 2/4, 3/4, 4/4, 5/4, 3/8, 6/8, 7/8, 9/8, 12/8. <input checked="" type="checkbox"/> When the setting 1/4 is selected, it produces only the click sounds without an accent beat. The default setting is 4/4. 100 rhythm types are available. P83 Drum Rhythm List
Volume	The metronome volume can be specified in the range from 1 to 10. The default setting is 5.

Setting the Metronome

1. Press and hold the [METRONOME] button to enter the Metronome settings screen.
2. Press the [UP]/[DOWN] button to select the settings menu.
3. Press the [LEFT]/[RIGHT] button to set the value.



- Pressing the [LEFT]/[RIGHT] buttons simultaneously will restore the default setting.
- Pressing the [3] button will return to the Home screen.

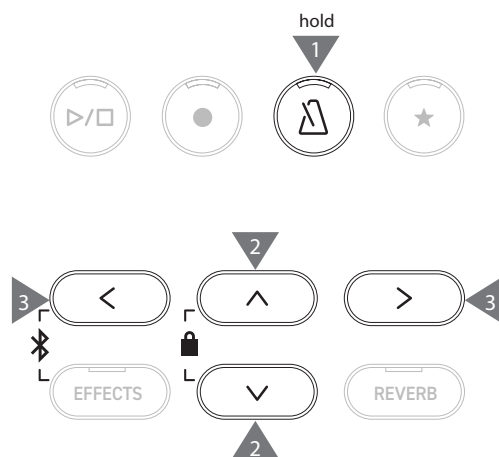

Recorder

This instrument allows songs to be recorded and played back. This instrument is equipped with an Internal Recorder to record/playback songs to/from internal memory, and a USB Recorder to record/playback songs to/from USB memory device.

Recording format

Internal memory

- Internal format

USB memory device

- MP3 format
Bitrate: 256 kbit/s fixed, Sampling frequency: 44.1 kHz, Stereo
- WAV format
Sampling frequency: 44.1 kHz, 16 bit, Stereo

Internal Recorder

- This instrument allows up to 10 songs to be recorded, stored in internal memory. Each song consists of two separate parts. This allows the right hand and left hand to be recorded into separate parts and played back separately for practicing one hand. These parts can also be played back together.
- When a song is recorded to the song memory containing performance data, the existing performance data will be overwritten by the new performance data.
- When recording into part 2 without playing back part 1 which is already recorded, set part 2 to be played back in song recorder mode.
- The total recording capacity of this instrument is approximately 90,000 notes. The LED indicators for the [PLAY/STOP] button and [REC] button turn off and recording stops if the memory becomes full while recording. Performances are recorded until immediately before the recorder stops.



Rough guide for the total recording capacity:

For example, if the total recording capacity is 5,000 notes, Beethoven's Für Elise can be recorded three to four times, or recording of 10 to 15 minutes is possible.

However, the recording time varies depending on the number of notes in the piece and tempo of the piece.

The recording time is also affected by the number of times the pedal is depressed because the recorder records pedal operations, too.

- The recorded contents are not erased by turning this instrument off.

Recording to a USB memory device

- This instrument is capable of recording performances directly to a USB memory device in audio format.
- The USB Recorder will also capture Bluetooth audio sound, allowing the performances played with backing music to be recorded.



Sound from the LINE IN connectors will not be captured by the USB Recorder.

Panel operations while recording with the Internal Recorder

- The sound selected before recording, and sounds selected during recording will be stored.
- Changes to the effect settings will not be stored.
- The tempo setting will not be stored.

Files that can be played back

This instrument can play back the following data:

- Songs that are recorded to store in internal memory.
- SMF files stored in a USB memory device (Format 0, Format 1)
- KSO files stored in a USB memory device (internal song format files)
- MP3 files stored in a USB memory device (Bitrate: 8~320 kbps, Sampling frequency: 44.1 kHz, 48 kHz, or 32 kHz, Stereo)
- WAV files stored in a USB memory device (Sampling frequency: 44.1 kHz, 16 bit, Stereo)

Recording to internal memory and playing back

Recording to internal memory

1. Press the [REC] button to enter the Internal Recorder screen.
The LED indicator for the [REC] button will start to flash once the Internal Recorder screen opens.



✓ If a USB memory device is connected, press the [1] button to display the Internal Recorder screen.

2. Press the [UP]/[DOWN] button to select the "Song" or "Part".
3. Press the [LEFT]/[RIGHT] button to set the song memory or part to be recorded.
4. Press the [PLAY/STOP] button to start recording.
Recording can also be started by pressing a key.
When the recording starts, the LED indicators for the [REC] button and the [PLAY/STOP] button will turn on.
5. Press the [PLAY/STOP] button to finish recording.
When the recording ends, the LED indicators for the [PLAY/STOP] button and the [REC] button will turn off.
A "✖" symbol will appear beside the recorder song.
The display automatically enters song playback mode.



Song playback mode

- The performances can be recorded with the Metronome function turned on by pressing the [METRONOME] button.

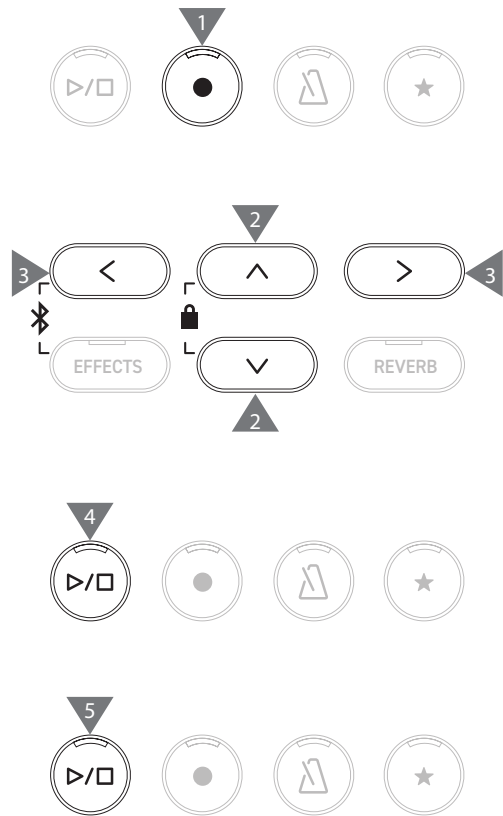

Playing back performances from internal memory

1. Press the [PLAY/STOP] button to enter song playback mode.



2. Press the [UP]/[DOWN] button to select the "Song" or "Part".
3. Press the [LEFT]/[RIGHT] button to select the song and part to play back.
4. Press the [PLAY/STOP] button to start the playback.
Press the [PLAY/STOP] button again to stop the playback.

- Pressing the [3] button will return to the Home screen.

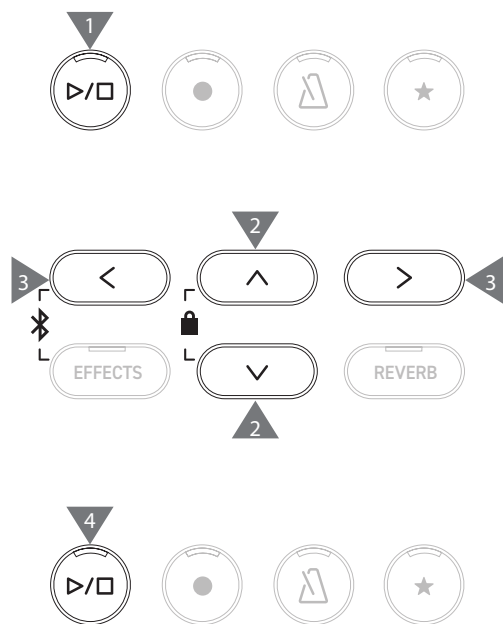

Playing back performances from internal memory with different settings

The following settings can be changed for the performances recorded in internal memory.

Internal Recorder function	Description	Page
Key Transpose	Transpose the pitch of the keyboard.	P47
Song Transpose	Transpose the pitch of the recorded song to be played back.	P47
Erase	Erase a song.	P19
Convert to Audio	Convert the recorded song into an MP3 file or a WAV file and store it in a USB memory device.	P20

1. On the song recorder mode, press the [2] button to enter the Internal Recorder Edit screen.



Internal Recorder Edit screen

2. Press the [UP]/[DOWN] button to select the settings menu.
 3. Press the [LEFT]/[RIGHT] button to set the value.
- Pressing the [LEFT]/[RIGHT] buttons simultaneously will restore the default setting.
 - Pressing the [3] button will return to song playback mode.

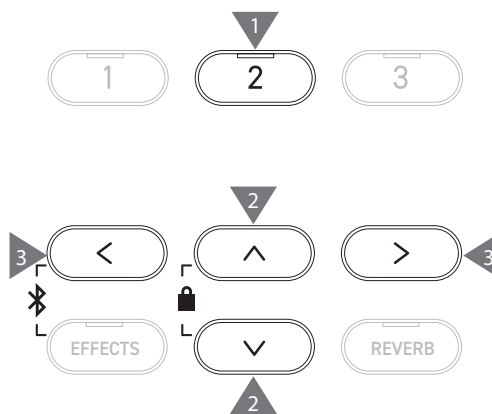

Erasing performances from internal memory

1. With "Erase" selected, press the [2] button to enter the Erase Song screen.



2. Press the [UP]/[DOWN] button to select the "Song" or "Part".



3. Press the [LEFT]/[RIGHT] button to select the song and part.
 4. A confirmation message appears when pressing the [2] button.
 5. Press the [1] button to erase, or press the [3] button to cancel.
- Press and hold [PLAY/STOP] and [REC] buttons while the instrument is turned off, and turn on the power to erase all recorded songs.

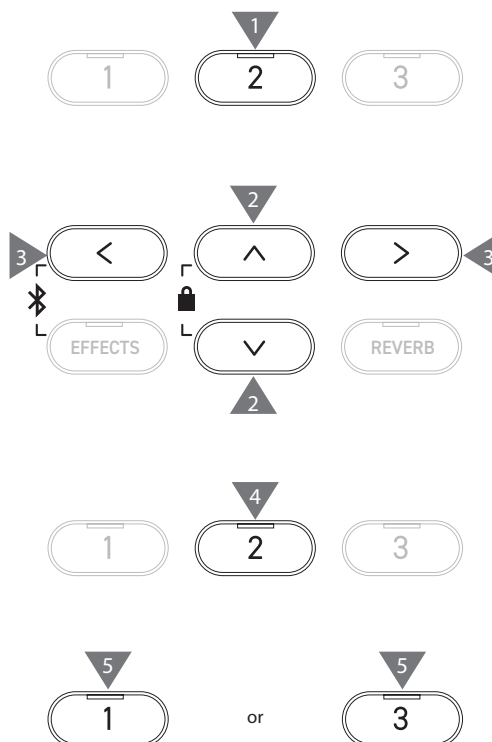

Recorder

■ Converting performances in internal memory

1. With "Conv. to Audio" selected, press the [2] button to enter the Convert to Audio screen.



2. Press the [UP]/[DOWN] button to select the "Song" or "Part".



3. Press the [LEFT]/[RIGHT] button to select the song and part.
4. Press the [2] button.



5. Press the [LEFT]/[RIGHT] button to select the target format. Select "MP3" or "WAV" format.
 6. Press the [PLAY/STOP] button to start conversion. Pressing any key will also start conversion. The LED indicators for the [PLAY/STOP] button and [REC] will turn off when the conversion starts.
- Keys pressed during the conversion are also recorded.

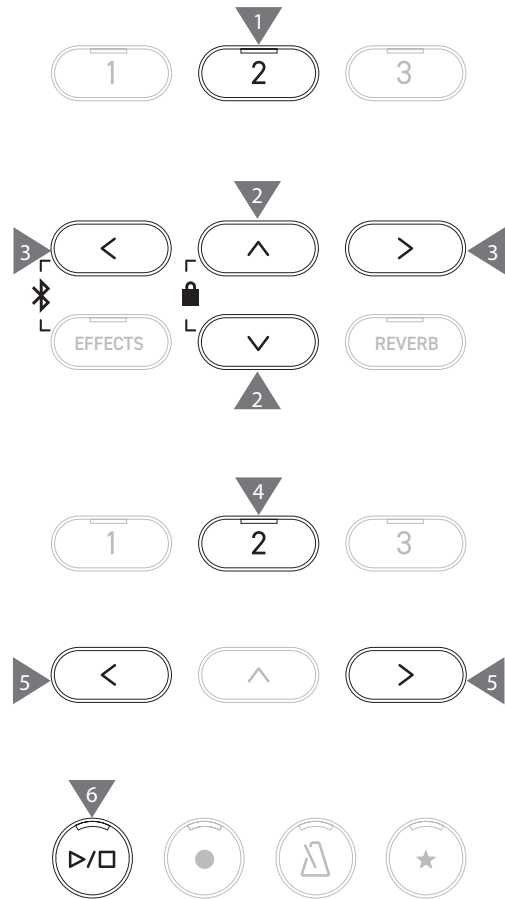

Recording to a USB memory device and playing back

Recording to a USB memory device

1. With a USB memory device connected to the instrument, pressing the [REC] button will enter the USB Recorder screen. The LED indicator for the [REC] button will start to flash once the USB Recorder screen opens.

The Internal Recorder screen appears if a USB memory device is not connected.

2. Press the [LEFT]/[RIGHT] button to select the target format.



Pressing the [1] button switches to the Internal Recorder screen.

3. Press the [2] button to enter the Gain Adjustment screen.



Gain Adjustment screen

The level meter is displayed on the Gain Adjustment screen. When the digital piano is played, recording levels are displayed separately for the L channel and R channel.

4. Press the [LEFT]/[RIGHT] button to adjust the gain. The gain can be adjusted in the range from 0 to 15 dB.

The recorded sound may become distorted if the Gain setting is set to a high level.

5. Press the [PLAY/STOP] button to start recording. Recording can also be started by pressing a key. The LED indicators for the [REC] button and [PLAY/STOP] button will turn on when recording starts.

- Pressing the [LEFT]/[RIGHT] buttons simultaneously will restore the default level.

Recording cannot be started from the Gain Adjustment screen.

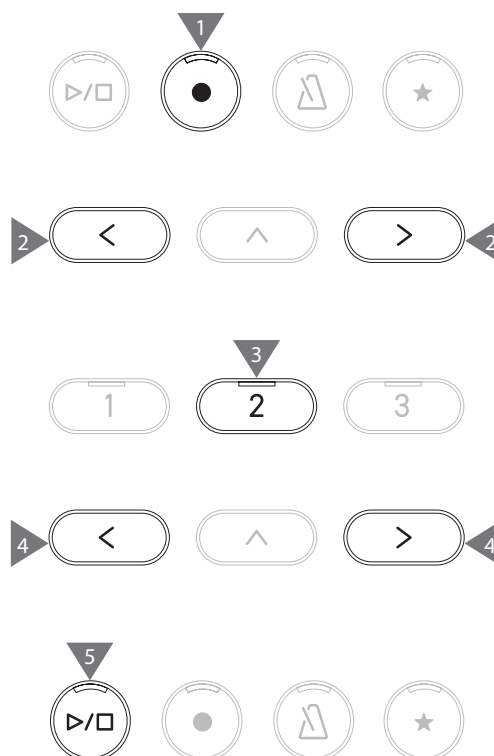

Saving the recorded performances

1. Press the [PLAY/STOP] button to stop recording.
The LED indicators for the [PLAY/STOP] button and [REC] will turn off when recording stops.
2. Press the [1] button to save the recorded performance to a USB memory device, or press the [3] button to cancel.



Specify the name for the song to be saved to the USB memory device.

3. Press the [LEFT]/[RIGHT] button to move the cursor and press the [UP]/[DOWN] button to change characters.
4. Press the [2] button after entering the song name to save the recording.
5. In the case where a file with the same name already exists, press the [1] button to overwrite, or press the [3] button to cancel.

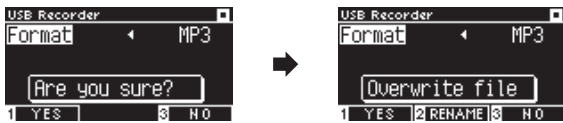

When a file with the same name exists

The LCD display returns to step 2 when canceled.

- The LCD display returns to song recorder mode automatically after saving the file.



The recorded audio file will be saved in the root folder of the USB memory device.
It is not possible to save the file in a different folder.

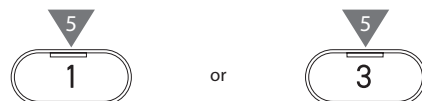
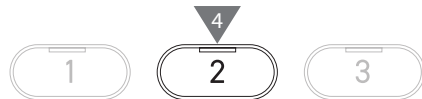
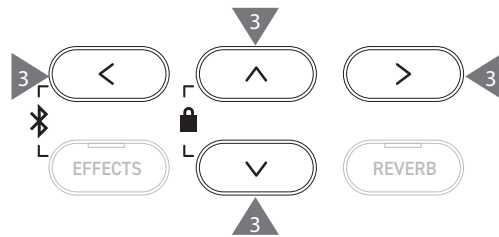
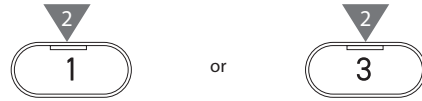

Characters that can be used

0-9	A-Z	a-z	!	#	\$	%	&	'	()	+	,	-	.	;	=	@	[]	^	_	`	{ }
-----	-----	-----	---	---	----	---	---	---	-----	---	---	---	---	---	---	---	-----	---	---	---	-----

Playing back songs in a USB memory device

- With a USB memory device connected to the instrument, pressing the [PLAY/STOP] button will enter the Song Browser screen. Contents of the root folder are shown if a USB memory device is connected.



- Press the [UP]/[DOWN] button to move the selection cursor.
- Press the [2] to select the song or enter the folder.
- Press the [PLAY/STOP] button to play back. Press the [PLAY/STOP] button again to stop.

- Pressing the [3] button after stopping playback will return to the Song Browser screen.

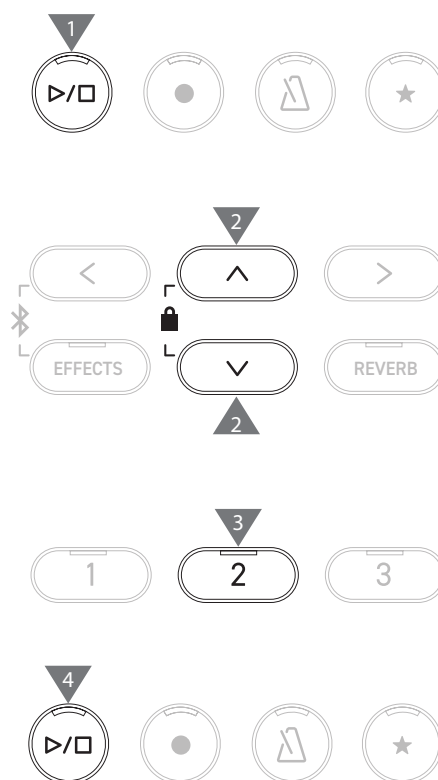

Song Browser screen

indicates a folder.



Returns to the upper folder.

indicates a song.

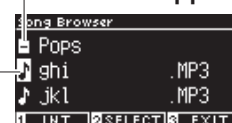

Returns to the Home screen.

Displays the Internal Recorder screen.

LCD display and buttons while playing back an SMF, KSO, MP3, or WAV file

<MP3 or WAV file>

<KSO file (internal song file)>

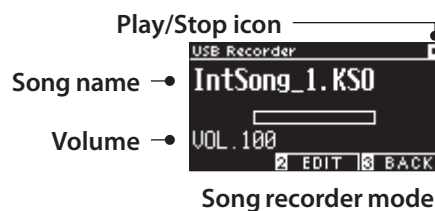
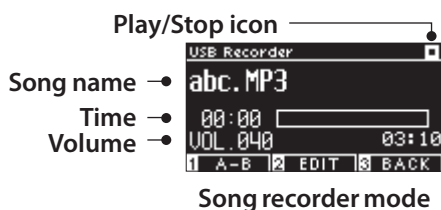

<SMF file>

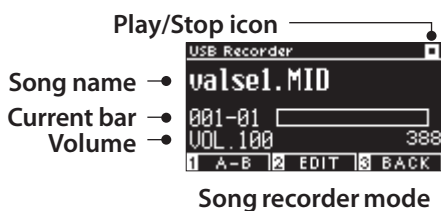

- While the volume of commercial audio files are maximized in the mastering process, normal recording volume of the instrument (piano) is quieter because of the wide dynamic range of the instrument. Therefore, volume adjustment may be required.
- Folder names, file names, song names, and artist names will not be displayed correctly if they contain characters that cannot be recognized by the instrument.

Setting an A-B repeat

1. While playing a song in a USB memory device, press the [1] button to specify the start point (A) of the loop.
2. Upon reaching the desired position, press the [1] button again to specify the end point (B) of the loop.
The repeat will be canceled if the [1] button is pressed again.

An A-B repeat cannot be set for KSO files.

Playing back performances from a USB memory device with different settings

The following settings can be specified for performances in a USB memory device.

USB Recorder function	Description
Play Mode	Select the desired play mode.
Tempo	Set the tempo. <input checked="" type="checkbox"/> This setting is displayed only when an SMF or KSO file is selected.
Key Transpose	Transpose the pitch of the keyboard.
Song Transpose	Transpose the pitch of the recorded song to be played back. <input checked="" type="checkbox"/> This setting is displayed only when an SMF or KSO file is selected.
Song Part	Set play or mute on each part. Set "Play" for the part to be played, and "Mute" for the part to be muted. <input checked="" type="checkbox"/> This setting is displayed only when an SMF file is selected.

1. On the song recorder mode, press the [2] button to enter the USB Recorder Edit screen.

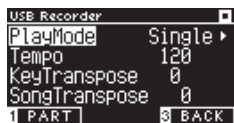

USB Recorder Edit screen

2. Press the [UP]/[DOWN] button to select the settings menu.
3. Press the [LEFT]/[RIGHT] button to set the value.

- Pressing the [LEFT]/[RIGHT] buttons simultaneously will restore the default setting.
- Pressing the [3] button will return to song recorder mode.

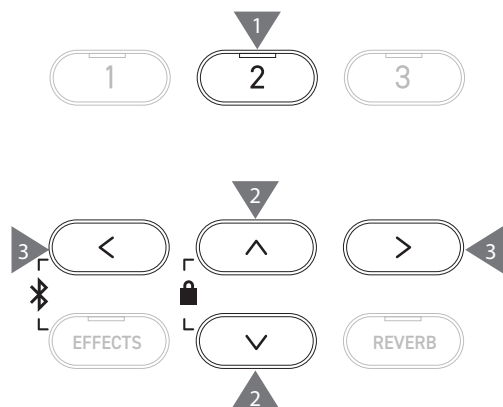

Play Mode settings

There are four play modes.

Play Mode setting	Description
Single	Play the selected song once.
1 Repeat	Play the selected song repeatedly.
All Repeat	Play the songs in the selected folder repeatedly.
Random	Play the songs in the selected folder randomly.

Playing or muting a song part

1. On the USB Recorder Edit screen, press the [1] button.

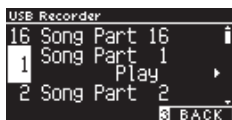

2. Press the [UP]/[DOWN] button to select a song part.
3. Press the [LEFT]/[RIGHT] button to switch between "Play" and "Mute".

✓ If a song part does not contain any performance data, "No data" will be displayed.

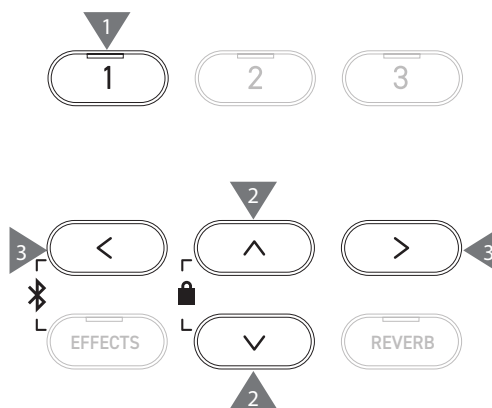

Overdubbing data in a USB memory device

1. With a USB memory device connected to the instrument, pressing the [PLAY/STOP] button will enter the Song Browser screen.
2. Press the [UP] or [DOWN] button to move the selection cursor over the song to be overdubbed.



3. Press the [REC] button to enter the USB Recorder screen. The LED indicator for the [REC] button will start to flash once the USB Recorder screen opens.
4. Press the [UP]/[DOWN] button to select a "Mode".
5. Press the [LEFT]/[RIGHT] button to select a mode as follows.
 - Select "Over Dubbing" if it is MP3 or WAV data.

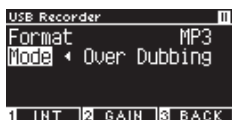

- Select "Conv.to Audio" if it is SMF or KSO data.

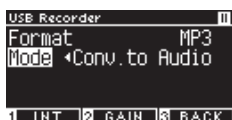

6. Press the [PLAY/STOP] button to start recording. Recording can also be started by pressing a key. The LED indicators for the [REC] button and [PLAY/STOP] button will turn on when recording starts.

P22 Saving the recorded performances

✓

- SMF and KSO data is converted to MP3/WAV data when overdubbing.
- Normal recording will start if "New Song" is selected instead of overdubbing.

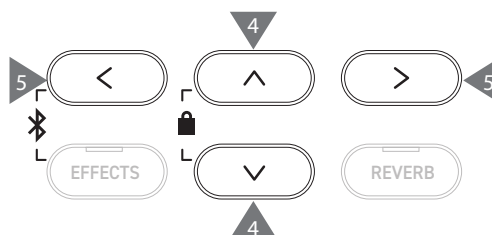
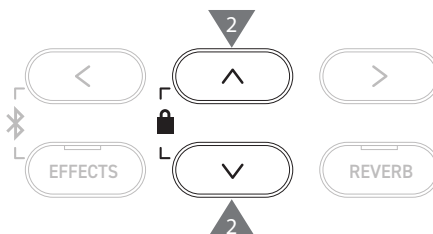

Reverb

The Reverb setting adds reverberation to the sound.

Turning Reverb on/off

- Press the [REVERB] button.
The LED indicator for the [REVERB] button will turn on and the reverberation effect is applied.
- The reverberation effect is removed and the LED indicator for the [REVERB] button is turned off if the [REVERB] button is pressed again.



List of reverb settings

Reverb setting	Description
Type	Sets one of the six available reverb types.
Depth	Sets the reverb depth in the range from 1 to 10.
Time	Sets the reverb time in the range from 1 to 10.

List of reverb types

Type	Description
Room	Simulates the reverberation of a performance in a small rehearsal room.
Lounge	Simulates the reverberation of a performance in a piano lounge.
Small Hall	Simulates the reverberation of a performance in a small hall.
Concert Hall	Simulates the reverberation of a performance in a large concert hall for classical music.
Live Hall	Simulates the reverberation of a performance in a large hall for live music performance.
Cathedral	Simulates the reverberation of a performance in a large cathedral.

Reverb settings

1. Press and hold the [REVERB] button to enter the Reverb Edit screen.

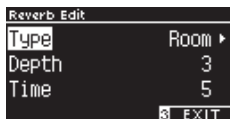

2. Press the [UP]/[DOWN] button to select the settings menu.
 3. Press the [LEFT]/[RIGHT] button to set the value or type.
- Pressing the [LEFT]/[RIGHT] buttons simultaneously will restore the default setting.
 - Pressing the [3] button will return to the Home screen.

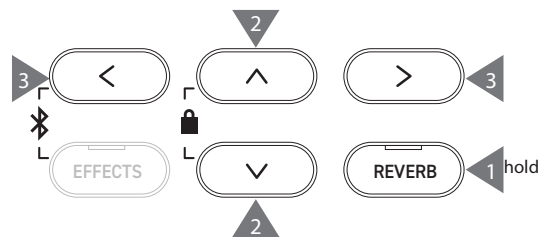

Effects

The effect function allows various effects to be added to the sound.

Turning Effects on/off

- Press the [EFFECTS] button.
The LED indicator for the [EFFECTS] button will turn on and the effect is applied.
- The effect is removed and the LED indicator for the [EFFECTS] button is turned off if the [EFFECTS] button is pressed again.

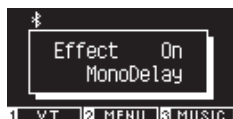
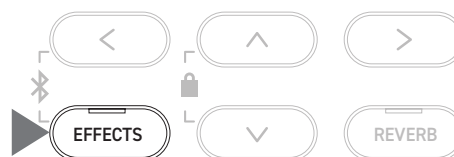

List of effect types

Effect type	Description
Mono Delay	This effect adds a mountain-like echo to the sound.
Ping Delay	This effect echoes the sound alternately left and right.
Triple Delay	This effect echoes the sound in the order of center, right, and left.
Chorus	This effect expands the sound by matching the original sound with a sound that has pitch fluctuations.
Classic Chorus	This effect reproduces the chorus of yesteryear by digital signal processing.
Ensemble	This effect adds richness to the sound with a three-phase chorus.
Tremolo	This effect gives fluctuations to the volume.
Classic Tremolo	This effect reproduces the tremolo of yesteryear by digital signal processing.
Vibrato Tremolo	This effect adds vibrato to tremolo.
Tremolo+Amp	This effect reproduces the change in sound caused by the amplifier and combines it with tremolo.
Auto Pan	This effect periodically changes the position where the sound can be heard.
Classic Auto Pan	This effect reproduces the auto pan of yesteryear by digital signal processing.
Auto Pan+Amp	This effect reproduces the change in sound caused by the amplifier and combines it with the auto pan.
Phaser+AutoPan	This effect adds the auto pan to the phaser.
Phaser	This effect makes the sound fly around by matching an out-of-phase sound with the original sound.
Classic Phaser	This effect reproduces the phaser of yesteryear by digital signal processing.
Phaser+Amp	This effect reproduces the change in sound caused by the amplifier and combines it with the phaser.
Phaser+Chorus	This effect adds chorus to the phaser.
Rotary1	This effect reproduces the change in sound caused by the rotary speaker. You can switch the speed of rotation by stepping on the soft pedal (left pedal).
Rotary2	This effect adds a little distortion to Rotary1.
Rotary3	This effect adds more distortion to Rotary2.
Rotary4	This effect adds chorus to Rotary1.
Rotary5	This effect adds chorus to Rotary2.
Rotary6	This effect adds chorus to Rotary3.

List of effect settings

Settings of the effects can also be adjusted.

Effect type	Effect setting	Effect (when the number is increased)
Delay 3 types	Effect level	The degree of applying effect will be deeper.
	Time	The interval between echoes will be longer.
Chorus, Ensemble	Effect level	The degree of applying effect will be deeper.
	Speed	The speed of fluctuations will be faster.
Classic Chorus	Mono / Stereo	The sound will spread deeper.
	Speed	The speed of fluctuations will be faster.
Tremolo 3 types Auto Pan 2 types, Phaser 2 types	Effect level	The degree of applying effect will be deeper.
	Speed	The speed of fluctuations and undulations will be faster.
Rotary 6 types	Accel. Speed	The speed when changing between slow and faster will be faster.
	Rotary Speed	The faster speed will increase.
[Effect]+[Effect]	Effect level	The degree of applying effect will be deeper.
[Effect]+Amp	Speed	The speed of fluctuations and undulations will be faster.

Effects settings

1. Press and hold the [EFFECTS] button to enter the Effects Edit screen.

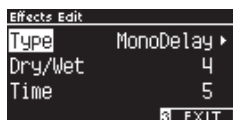

2. Press the [UP]/[DOWN] button to select the settings menu.
3. Press the [LEFT]/[RIGHT] button to set the value or type.

- Pressing the [LEFT]/[RIGHT] buttons simultaneously will restore the default setting.
- Pressing the [3] button will return to the Home screen.

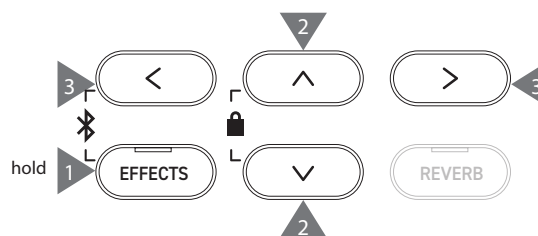

Dual

The Dual function allows two sounds to be layered together.

Entering Dual

Press two SOUND buttons to be layered simultaneously. The LED indicators for the pressed SOUND buttons will turn on and the names of the sounds will appear on the LCD display.

The sound that is pressed first is displayed on the first line as Part 1.

Example:

To layer [PIANO1] and [STRINGS] sounds, press the [PIANO1] and [STRINGS] buttons simultaneously as shown in Figure 1. They will appear on the display as shown in Figure 2.



The display may show shortened sound names.

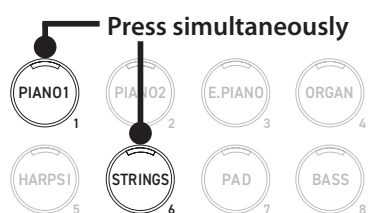

Figure 1



Figure 2

Selecting a sound for each part

1. On the Dual screen, press the [UP]/[DOWN] button to select the sound part.
2. Press the [LEFT]/[RIGHT] button to set the sound variation of the selected part.

P81 Sound/Demo Songs List

- Pressing the [3] button will return to the Home screen.
Or, pressing any single SOUND button will return to the Home screen.

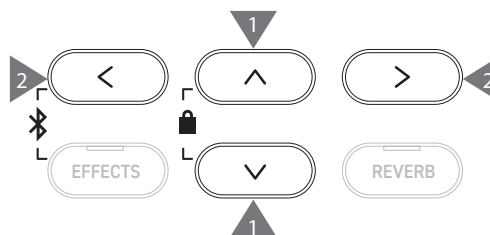

Dual Settings

List of Dual settings

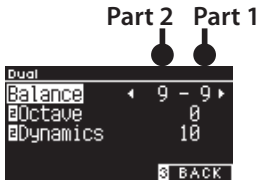
Dual Edit setting	Default setting	Description
Balance	9-9	Adjust the volume balance of the two sounds. 
[2] Octave (Layer Octave Shift)	0	Adjust the sound range of Part 2 in Dual between -2 and +2 octaves. For example, if "SK-EX Concert Grand Piano Concert" and "String Ensemble" are combined in dual mode, the sound of "String Ensemble" can be played an octave higher.
[2] Dynamics (Layer Dynamics)	10	Adjust the dynamic sensitivity of Part 2 in Dual between 1 and 10. The smaller the number, the lower the dynamic sensitivity. For example, lowering the dynamic sensitivity of "String Ensemble" in a performance of "SK-EX Concert Grand Piano Concert" and "String Ensemble" in Dual can improve the dynamics of the piano sound.

Dual settings

- On the Dual screen, press the [2] button to enter the Dual Edit screen.



Dual Edit screen

- Press the [UP]/[DOWN] button to select the settings menu.
 - Press the [LEFT]/[RIGHT] button to set the value.
- Pressing the [LEFT]/[RIGHT] buttons simultaneously will restore the default setting.
 - Pressing the [3] button twice will return to the Home screen.

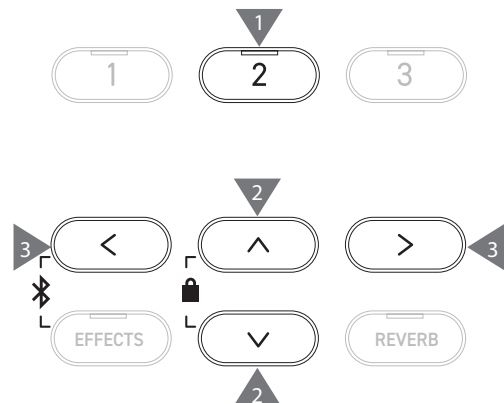

Split

The Split function divides the keyboard into lower and upper sections, each of which can be played with a different sound. The point that divides lower and upper sections is called the “split point”.

Entering Split

- On the Dual screen, press the [1] button to enter the Split screen.
- The LED indicator for the SOUND button assigned to the upper section will turn on.
- The LED indicator for the SOUND button assigned to the lower section will flash.



- By default, the lower section will be set to the “Wood Bass” sound.
- Pressing the [3] button will return to the Home screen.

Changing the split point

Press and hold the [1] button, then press the desired split key on the keyboard. The pressed split key will become the lowest note in the upper section.

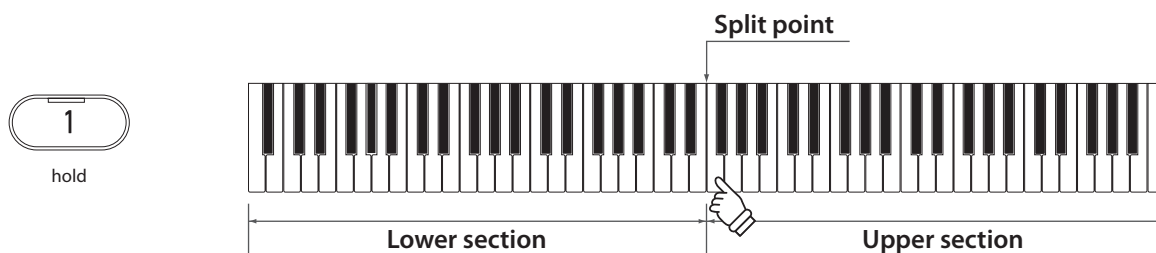

- The default setting of the split point is C4.

Changing the upper/lower section sounds

- Press a SOUND button to set the sound for the upper section.
Press and hold the [1] button, then press a SOUND button to set the sound for the lower section.

Upper section

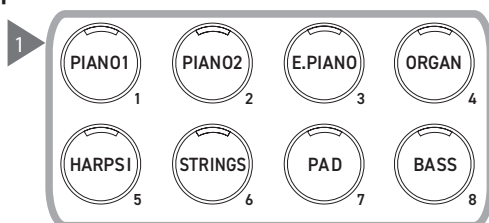

Lower section

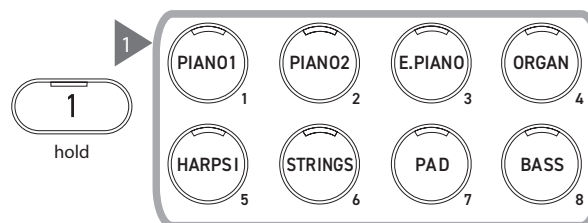



- Press the [LEFT]/[RIGHT] button to set the sound for each section.



Split Settings

List of split settings

Split Edit setting	Default setting	Description
Balance	9-9	Adjust the volume balance of the two sounds. <div style="text-align: center;"> Lower section Upper section   </div>
<input type="checkbox"/> Octave (Lower Octave Shift)	0	Adjust the sound range of the lower section in Split between 0 and +3 octaves.
<input type="checkbox"/> Pedal (Lower Pedal)	Off	Set the damper pedal function on or off for the lower section in Split. The pedal function is always on for the upper section.
Split Point	C4	Set the split point in the range from A0 to C#8.

Split settings

- On the Split screen, press the [2] button to enter the Split Edit screen.



Split Edit screen

- Press the [UP]/[DOWN] button to select the settings menu.
 - Press the [LEFT]/[RIGHT] button to set the value or type.
- Pressing the [LEFT]/[RIGHT] buttons simultaneously will restore the default setting.
 - Pressing the [3] button twice will return to the Home screen.

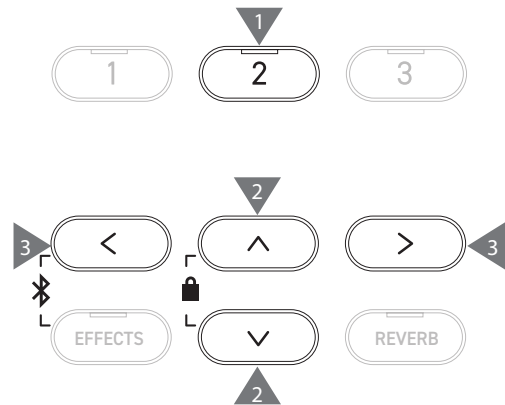

4 Hands

The Four Hands function divides the keyboard into left and right sections, each of which can be played in the same key range. At this time, the damper pedal (right) acts as a damper pedal for the right section, and the soft pedal (left) acts as a damper pedal for the left section.

Entering Four Hands

- On the Split screen, press the [1] button to enter the Four Hands screen.

The LED indicator for the SOUND button assigned to the right section will turn on.

The LED indicator for the SOUND button assigned to the left section will flash.

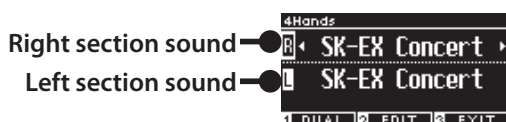

- By default, the right and left sections will both be set to the "SK-EX Concert Grand Piano | Concert" sound.
- Pressing the [3] button will return to the Home screen.

Changing the Four Hands split point

Press and hold the [1] button, then press the desired split key on the keyboard.

The pressed split key will become the lowest note in the right section.

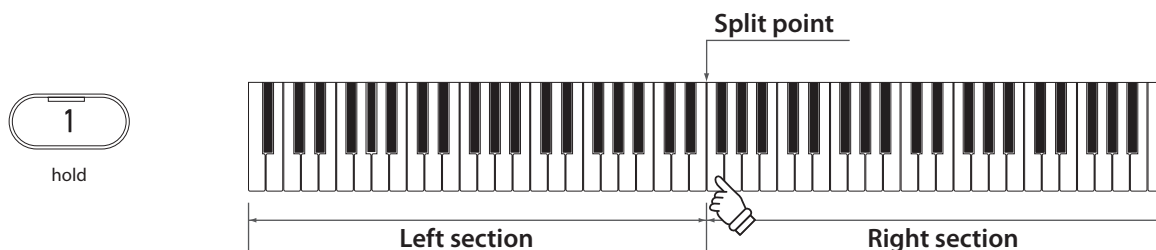

- The default setting of the split point is F4.

Changing the right/left section sounds

- Press a SOUND button to set the sound for the right section.

Press and hold the [1] button, then press a SOUND button to set the sound for the left section.

Right section

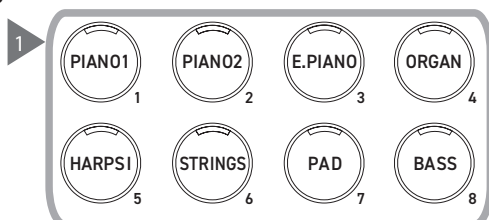

Left section

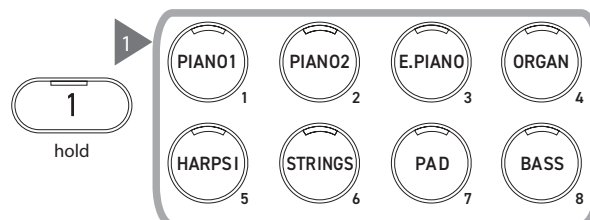



- Press the [LEFT]/[RIGHT] button to set the sound for each section.



Four Hands Settings

List of Four Hands settings

Four Hands Edit setting	Default setting	Description
Balance	9-9	Adjust the volume balance of the two sounds. <div style="text-align: center;"> <p>Left section Right section</p>  </div> 
Octave (Right Octave Shift)	-2	Adjust the sound range of the right section between -3 and 0 octaves.
Octave (Left Octave Shift)	2	Adjust the sound range of the left section between 0 and +3 octaves.
Split Point	F4	Set the split point in the range from A0 to C#8.

Four Hands settings

- On the Four Hands screen, press the [2] button to enter the Four Hands Edit screen.

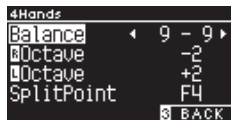

Four Hands Edit screen

- Press the [UP]/[DOWN] button to select the settings menu.
 - Press the [LEFT]/[RIGHT] button to set the value.
- Pressing the [LEFT]/[RIGHT] buttons simultaneously will restore the default setting.
 - Pressing the [3] button twice will return to the Home screen.

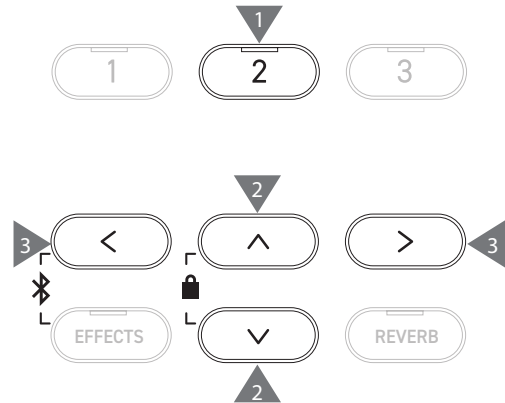

Music Menu

The Music Menu contains four functions consisting of Demo Songs, Piano Music, Lesson, and Concert Magic.

Music Menu list

Function	Description
Demo Songs	A selection of short songs to demonstrate each sound. <div style="border: 1px solid black; padding: 2px; display: inline-block;">P81 Sound/Demo Songs List</div>
Piano Music	A selection of 29 popular piano works ranging from the Baroque period such as Rameau, to the Romantic period such as Chopin. Notated scores are provided in the separate "Classical Piano Collection" book*. <input checked="" type="checkbox"/> <div style="border: 1px solid black; padding: 2px; display: inline-block;">Depending on market location.</div>
Lesson	A collection of contemporary lesson songs and classical etudes. For a complete listing of available Lesson songs, please refer to the separate "Internal Song Lists" booklet.
Concert Magic	A selection of 176 Concert Magic songs. The Concert Magic function allows players to experience a real piano performance by simply tapping any key with their finger. Concert Magic songs can also be played back as demo songs. For a complete listing of available Concert Magic songs, please refer to the separate "Internal Song Lists" booklet.

Entering the Music Menu mode

- On the Home screen, press the [3] button to enter the Music Menu screen.

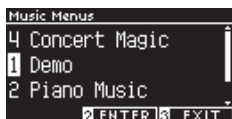

- Press the [UP]/[DOWN] button to select the function to use.
- Press the [2] button to enter the selected function.

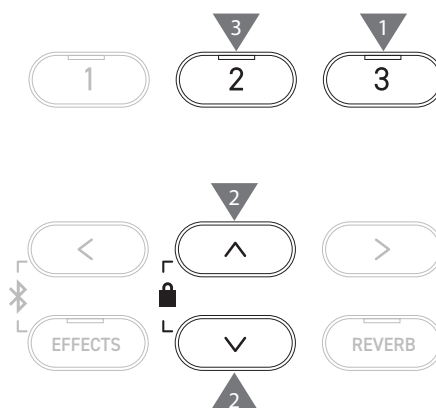

Music Menu

Demo Songs

Playing/Stopping demo songs

- A demo song starts when the Demo Songs screen appears.

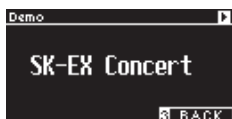

- Pressing the [PLAY/STOP] button will stop the song.
- Pressing the [PLAY/STOP] button again will play the song from the beginning.

Changing demo songs

- The demo song changes if the sound is changed by pressing the SOUND button or an ARROW button in the Demo Songs screen.
- Demo songs can be changed during playback.

Piano Music

☑ Depending on market location.

Selecting a piano music piece

On the Piano Music screen, press the [UP]/[DOWN] button or [LEFT]/[RIGHT] button to select a song.

The song name appears in the upper section and the composer name appears in the lower section of the LCD display.

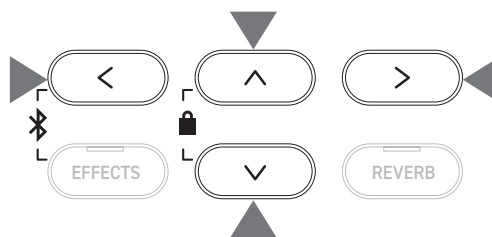

Listening and stopping a piano music piece

- Pressing the [PLAY/STOP] button will replay the piano music piece.
- Pressing the [PLAY/STOP] button again will stop the song.



Lesson

Lesson song books

Alfred Lesson Books	Classical Lesson Books
Alfred's Premier Piano Course Lesson 1A	Burgmüller 25 (25 Etudes Faciles, Opus 100)
Alfred's Premier Piano Course Lesson 1B	Czerny 30 (Etudes de Mécanisme, Opus 849)
Alfred's Basic Piano Library Lesson Book Level 1A	Czerny 100 (Hundert Übungsstücke, Opus 139)
Alfred's Basic Piano Library Lesson Book Level 1B	Beyer 106 (Vorschule im Klavierspiel, Opus 101)
Alfred's Basic Adult Piano Course Lesson Book Level 1	J.S. Bach: Inventionen
	Sonatinen Album 1
	Chopin Walzer (Chopin waltzes series 1-19)

☑ Lesson books sold separately – please refer to the separate “Internal Song Lists” booklet for more information.

Selecting a song

1. On the Lesson screen, press the [UP]/[DOWN] button to select the item to set (book name, song title, or current bar).
2. Press the [LEFT]/[RIGHT] button to set the item.

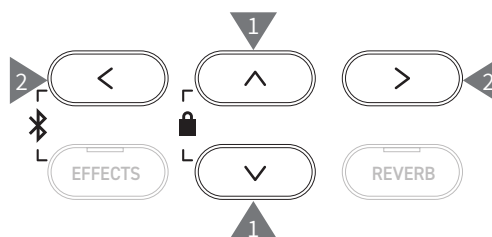

☑ The lesson song can be changed during playback. However, it is not possible to change the lesson song during recording.

Practicing

The Lesson function allows players to practice the piano in the six methods listed below.

■ Playing a lesson song and learning the songs

Playing back and stopping a song

With a lesson song selected, press the [PLAY/STOP] button.
The LED indicator for the [PLAY/STOP] button will turn on.
The lesson song playback starts after a one-bar count-in of the metronome.



- Pressing the [PLAY/STOP] button again will stop the lesson song.
- After stopping the song, pressing the [PLAY/STOP] button again will resume playback from 2 bars prior to where it was stopped. The song is played from the beginning when [EFFECTS] and [REVERB] buttons are pressed together.
- Pressing the [METRONOME] button will turn the metronome on.

Playing from the middle of the song

Select a lesson song to play back and press the [EFFECTS] or [REVERB] button.

Pressing the [EFFECTS] button move the playback position a bar backward and pressing the [REVERB] button move the playback position a bar forward.

Press and hold the button to go back/forward quickly.



Press the [UP]/[DOWN] button to select the beat of the bar.

Pressing the [LEFT] button move the playback position a beat backward and pressing the [RIGHT] button move the playback position a beat forward.

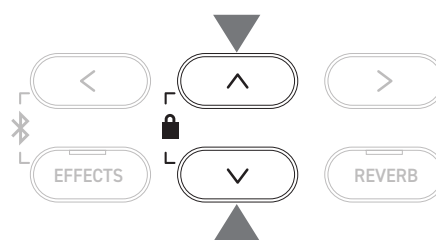

■ Practicing the right-hand (left-hand) parts while playing back the left-hand (right-hand) parts of a lesson song

1. On the Lesson screen, press the [2] button to enter the Lesson Edit screen.
2. Press the [UP]/[DOWN] button to select "Balance".
3. Press the [LEFT]/[RIGHT] button to adjust the volume of the left/right-hand part volume.

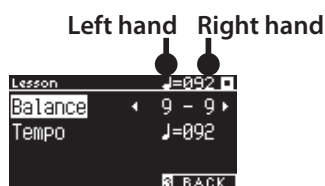

Lesson Edit screen

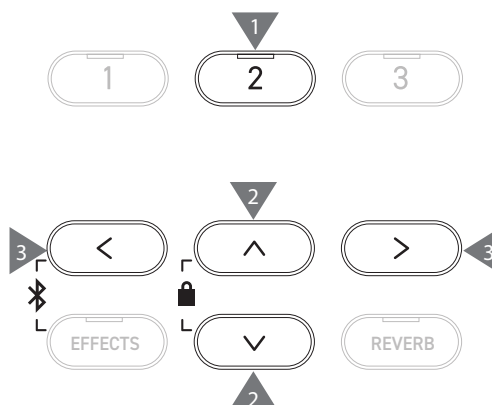

Practicing the right hand part while playing back the left hand part

Press the [LEFT] button.
The volume of the right hand part will be reduced.
The right hand part is muted when the value is 9-1.

Practicing the left hand part while playing back the right hand part

Press the [RIGHT] button.
The volume of the left hand part will be reduced.
The left hand part is muted when the value is 1-9.



- The sound quality may vary depending on the interval or timing of the performance when practicing along with a lesson song; however, this is not a fault.
- For some Beyer lesson pieces, increasing the value on the left will reduce the volume of the student's part, while increasing the value on the right will reduce the volume of the teacher's part.

Practicing by changing the tempo

1. On the Lesson Edit screen, press the [UP]/[DOWN] button to select "Tempo".
2. Press the [LEFT]/[RIGHT] button to adjust the value.

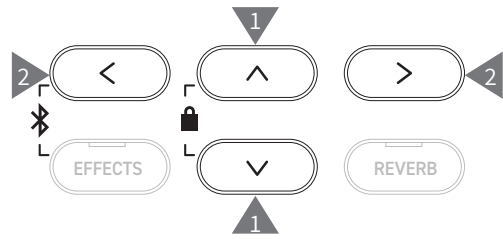

Practicing in an A-B repeat

Specify two bar positions within a lesson song to practice between these two positions repeatedly.

Method 1

1. While playing a lesson song, press the [1] button to specify the start point of the repeat.



The start point (A) is set and the LED indicator of the [1] button starts flashing.

2. Upon reaching the desired position, press the [1] button to specify the end point (B) of the repeat.



The end point (B) is set and the LED indicator of the [1] button turns on.

Once an A-B repeat is set, the playback position returns to 2 beats before the start point after reaching the end point.

3. Press the [1] button again to cancel the repeat point setting and restore the normal playback.



Method 2

Press the [EFFECTS] or [REVERB] button while stopping to set the bar positions of the repeat.

Note that the bar of the end point cannot be set earlier than the bar of the start point.



Recording the right (or left) hand part while playing the left (or right) hand part of a lesson song, and playing back

- With a lesson song selected, press the [REC] button.
The LED indicators for the [REC] button and [PLAY/STOP] button turn on, and the lesson song playback and recording start after a one-bar count-in of the metronome.
- Press the [PLAY/STOP] button to end recording.
The lesson song playback and recording end, and the LED indicators for the [REC] button and [PLAY/STOP] button will turn off.



- Pressing the [METRONOME] button will turn on the metronome for 1 bar before playing back the lesson song with the recorded performance.
- Pressing the [EFFECTS] or [REVERB] button will change the position to start playing back.
- Pressing the [PLAY/STOP] button again will stop the lesson song and the recorded performance.



- Repeat is disabled while the repeat points are set.
- The recorded performance is erased when the [REC] button and [PLAY/STOP] button are pressed simultaneously. It is also erased when another lesson song is selected.

Finger Exercises

The finger exercise function allows practicing and recording of “Hanon” (20 pieces in Part 1), or “major and minor scales, arpeggios, chords, and cadences”. Evaluation on evenness, etc. is shown on the LCD display to help with reviewing one’s own performance. It is also possible to listen to model performances of each Finger Exercise, like other lesson songs.

- With a “Hanon” piece selected, press the [REC] button.
The LED indicators for the [REC] button and [PLAY/STOP] button turn on, and the lesson song playback and recording start after a one-bar count-in of the metronome.
- Press the [PLAY/STOP] button to end recording.
The lesson song playback and recording end, and evaluation results of “Wrong notes”, “Timing problems”, and “Evenness” are displayed for a few seconds each repeatedly.
- Press the [PLAY/STOP] button to play the lesson song and the recorded performance.
This allows checking one’s own recorded performance while referring to the evaluation results.
Press the [PLAY/STOP] button again to stop the lesson song and the recorded performance.

- Pressing the [EFFECTS] or [REVERB] button will change the position to start playing back.
- Pressing the [UP]/[DOWN] button will end the evaluation display and return to the Lesson screen.



- Playback of the recorded performance is still possible after ending the display of the evaluation results.
- The recorded performance is erased when the [REC] button and [PLAY/STOP] button are pressed simultaneously.
- The recorded performance is also erased when another lesson song is selected.

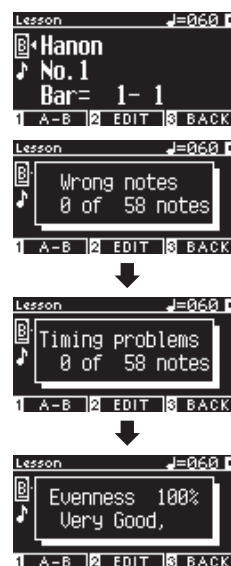

Concert Magic

Playing a Concert Magic song

Selecting a Concert Magic song

Two Concert Magic songs are assigned to each key.

- Bank A from A1 to A88 and Bank B from B1 to B88 contain 176 songs in total.

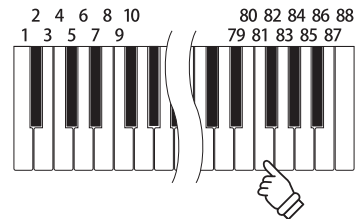
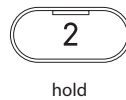

On the Concert Magic screen, press and hold the [2] button, then press a key to select the desired concert magic song. Press the same key again to switch between Bank A and Bank B.



Performing the selected Concert Magic song

- Tap any key to perform the concert magic song.
- The tempo of the song is determined by the tapping speed.
- The volume of the song is determined by the tapping force.
- Black circles (●) on the display change to plus symbols (+) as the song progresses. Use them as a guide for tapping.
- The sound can be changed by the same operation as the normal sound change operation.

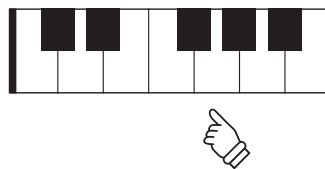

P81 Sound/Demo Songs List

Listening to a Concert Magic song

Random Play

With a concert magic song selected, press the [PLAY/STOP] button to play concert magic songs randomly. Press the [PLAY/STOP] button again to stop the playback.



Category Play

With a concert magic song selected, press and hold the [2] button and press the [PLAY/STOP] button to play all of the songs in the same group as the selected song repeatedly, in numerical order.

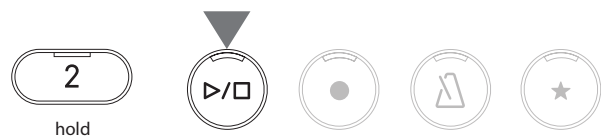

Concert Magic song settings

List of setting items

Concert Magic setting	Default setting	Description
Tempo	-	Set the tempo.
Mode	Normal	Normal
		Concert Magic songs will be performed according to their arrangement type.
		Steady Beat
		All Concert Magic songs will be performed by tapping the key with a constant beat.
Balance	9-9	Adjust the volume balance between the melody and accompaniment parts.

Concert Magic song arrangement types

Type	Description	Example
Easy Beat (EB)	Tap out a constant, steady beat on any key of the keyboard.	"Für Elise"
Melody Play (MP)	Tap out the rhythm of the melody on any key of the keyboard.	"Twinkle, Twinkle, Little Star"
Skillful (SK)	Tap out the rhythm of both the melody and the accompaniment notes on any key of the keyboard.	"Waltz of the Flowers"

Concert Magic song settings

1. On the Concert Magic screen, press the [2] button to enter the Concert Magic Edit screen.
2. Press the [UP]/[DOWN] button to select the settings menu.
3. Press the [LEFT]/[RIGHT] button to set the value or type.

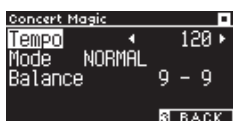

Concert Magic Edit screen

- Pressing the [LEFT]/[RIGHT] buttons simultaneously will restore the default setting.
- Pressing the [3] button twice will return to the Home screen.

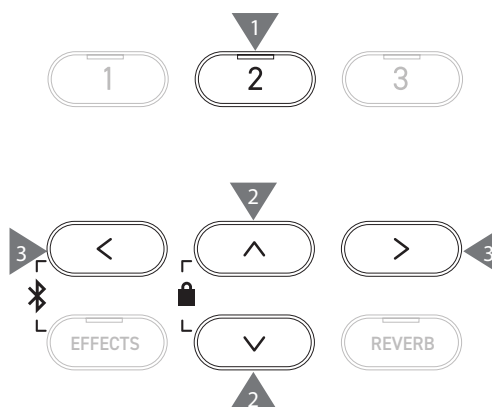

Steady Beat mode

Steady Beat mode allows all Concert Magic songs to be played by simply tapping any key with a constant steady beat, regardless of the song arrangement type.

Registration Memories

The registration function memorizes panel settings such as sounds and effects. Each Bank can store 8 different Registration memories, allowing 16 memories in total.



A collection of settings can be stored to a memory. This memory is called a "Registration".

Registration functions

Normal setting
Sounds (Including sound settings for Dual and Split)
Metronome
Reverb, Effects

Dual settings P30
Balance
Layer Octave Shift
Layer Dynamics

Split settings P42
Balance
Lower Octave Shift
Lower Pedal on/off
Split Point

Four Hands settings P34
Balance
Right Octave Shift
Left Octave Shift
Split Point

Basic Settings P46
Tuning
Tone Control
Damper Hold

Virtual Technician P51
Touch Curve
Voicing
Damper Resonance
Damper Noise
String Resonance
Undamped String Resonance
Cabinet Resonance
Key-off Effect
Fall-back Noise
Hammer Noise
Hammer Delay
Topboard Simulation
Decay Time
Release Time
Minimum Touch
Stretch Tuning
Temperament
Key Volume
Half-Pedal Adjust
Soft Pedal Depth

MIDI Settings
MIDI Channel
Local Control
Transmit Program Change No.
Multi-timbral Mode
Channel Mute

Recalling the registration

1. Press the [REGISTRATION] button to enter the Registration screen.
A previously stored registration will be recalled.
The registration name is displayed on the LCD display.
2. Press one of the eight registration memory SOUND buttons to select the registration to be recalled.
3. Press the or [1] button to alternate between Bank A and Bank B.



Bank A



Bank B

- Pressing the [REGISTRATION] button again will restore normal operation.

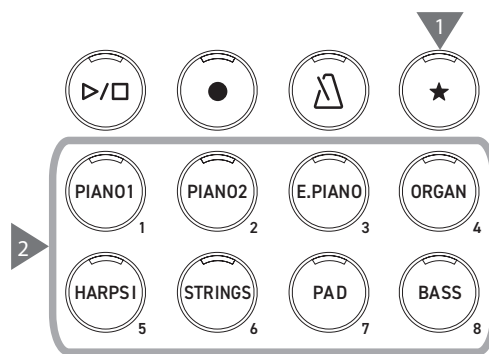

Storing a Registration memory

1. Press and hold the [REGISTRATION] button.
LED indicators for the eight registration memory SOUND buttons starts flashing.
Press the [1] or [2] button to select the Bank in which to store the registration.



2. Press one of the eight registration memory SOUND buttons to select the number to store the registration.
3. Press the [LEFT]/[RIGHT] button to move the cursor and press the [UP]/[DOWN] button to change characters to give a name to the registration.



4. Press the [2] button to store the registration. A beep will sound to confirm the operation.

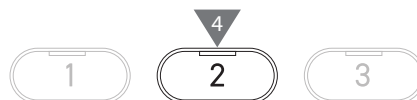
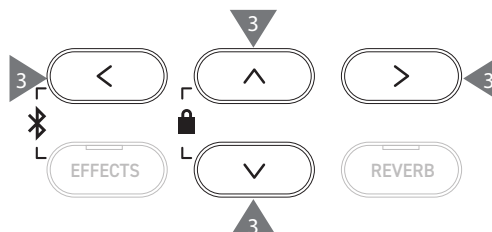
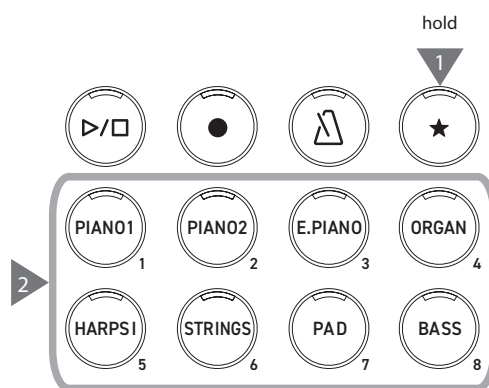

Checking and editing the selected registration

1. On the Registration screen, press the [2] button to enter the Registration Edit screen.

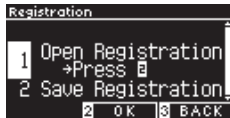

Registration Edit screen

2. Press the [UP]/[DOWN] button to select the "Open Registration" function.
 3. Press the [2] button.
- The instrument returns to the normal performance status while retaining the registration settings. This allows checking and editing of settings such as the sound and reverb.

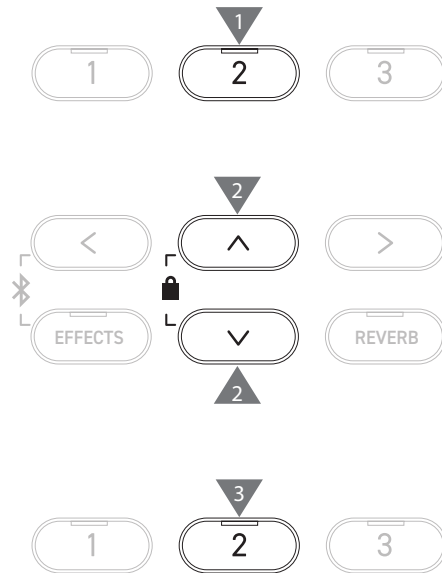

Saving the selected registration in a USB memory device

1. On the Registration Edit screen, press the [UP]/[DOWN] button to select "Save Registration".

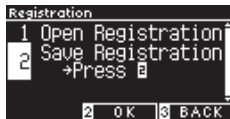

2. Press the [2] button to enter the screen to save the registration to a USB memory device.

P73 Save Registration Single

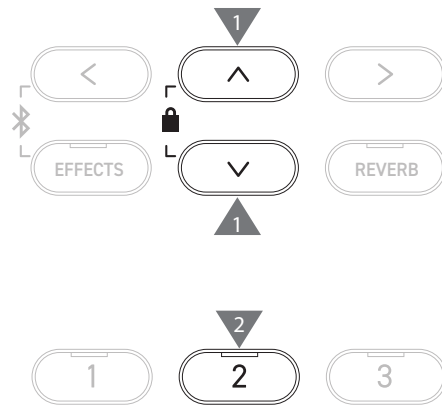

Resetting all Registration memories

Press and hold the [REGISTRATION] button and [REC] button while turning the instrument's power on to reset the registration settings to factory settings.

Panel Lock

This function locks the control panel.

Activating the Panel Lock

On the Home screen, press the [UP] and [DOWN] buttons simultaneously to enable the Panel Lock function.

The LED indicator for the [2] button starts flashing and panel lock will be activated.

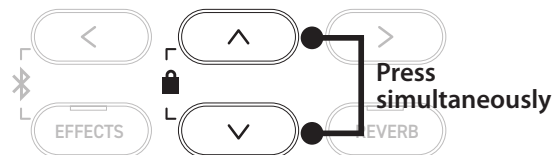

- Panel lock can be activated only in the Home screen (where the sound name is displayed). Panel lock cannot be activated in any other screen.
- Panel lock is not deactivated by turning off the power.

Deactivating the Panel Lock

Press and hold the [2] button.

This unlocks the panel operations.

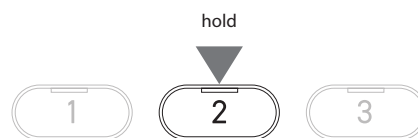

Settings Menu

Settings can be changed to suit playing conditions.

Settings Menu

Settings Menu	Description	Page
Basic Settings	Playing settings and save each settings.	P46
Virtual Technician	Simulate various adjustments on the piano electronically to find the right setting for the performer.	P51
Phones Settings	Headphone settings.	P62
MIDI Settings	MIDI settings. For more information on MIDI and its operation details, please download the supplementary PDF manual from the Kawai Global website: https://www.kawai-global.com/support/manual	
USB Menus	USB memory device settings.	P63
Bluetooth Settings	Bluetooth Audio and Bluetooth MIDI settings.	P77

Entering the Settings Menu

On the Home screen, press the [2] button to enter the Settings Menu screen.

Basic Settings

Basic Settings default values

Setting	Default setting	Page
1. Key Transpose	0C	P47
2. Song Transpose	0	P47
3. Tone Control	Flat	P48
4. Speaker Volume	Normal	P49
5. Low Volume Balance	3	P49
6. Tuning	440.0Hz	P49
7. Damper Hold	Off	P49
8. Split	Off	P31
9. Four Hands	Off	P33
10. Startup Setting	-	P50
11. Factory Reset	-	P50
12. Auto Display Off	5min	P50
13. Auto Power Off	-	P50



The above default settings can be overridden using the Startup Settings function.

Entering the Basic Settings screen

- On the Settings Menu screen, press the [UP]/[DOWN] button to select "Basic Settings".



- Press the [2] button to enter the Basic Settings screen.
- Press the [UP]/[DOWN] button to select the function to use.

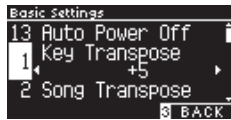

- Press the [LEFT]/[RIGHT] button to set the value or type.
- Pressing the [LEFT]/[RIGHT] buttons simultaneously will restore the default setting.

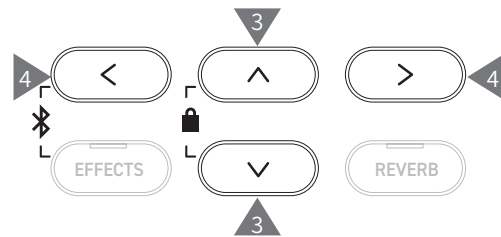
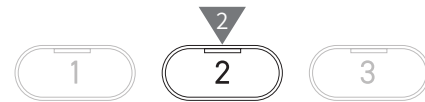
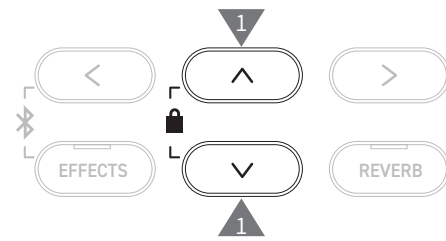

1 Key Transpose

The Key Transpose setting changes the pitch of the keyboard in semi-tone steps.

Key Transpose setting

The value can be specified in the range from -12 to +12 in semi-tone steps.

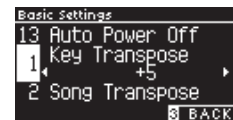

Checking the Key Transpose status

The transpose icon appears on the Home screen if Key Transpose is changed from its default setting 0.

LCD display when Key Transpose is set to the default value "0C"



LCD display when Key Transpose is set to "+5"



2 Song Transpose

The Song Transpose function transposes songs played from a USB memory device (SMF and KSO files), Internal Recorder, Piano Music, Lesson, and Concert Magic.

- Demo Songs cannot be transposed.

Song Transpose setting

Transposition can be specified in semi-tone steps.



3 Tone Control

The Tone Control setting allows players to optimise the sound quality in order to achieve the best sound quality within the area that the instrument is located.

Tone Control types

Type	Description
Flat	Tone control adjustment is not applied.
Brilliance	Adjusts the overall brightness of the sound.
Bass boost	Emphasises low-range frequencies, creating a deeper sound.
Bass cut	Reduces low-range frequencies, creating a clearer sound.
Mid boost	Emphasises mid-range frequencies, creating a harder sound.
Loudness	Emphasises frequencies to retain the instrument's sound character even at low volume levels.
Bright	Emphasises high-range frequencies, creating a brighter sound.
Mellow	Reduces high-range frequencies, creating a softer sound.
User	Allows the low, mid, and high-range frequency bands to be adjusted separately.

Adjusting the Brilliance level

Tone Control type Brilliance can adjust the brightness of the sound between -10 and +10.

1. With "Brilliance" selected, press the [2] button.

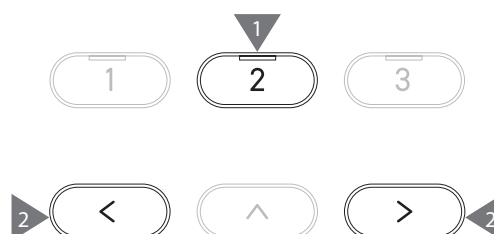

2. Press the [LEFT]/[RIGHT] button to set the value.
The greater the value the brighter of the sound.

Adjusting the User Tone Control value

1. With "User" selected, press the [2] button.



2. Press the [UP]/[DOWN] button to select the band to be adjusted.

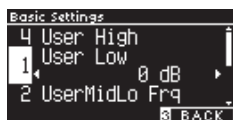

3. Press the [LEFT]/[RIGHT] button to set the volume and frequency.

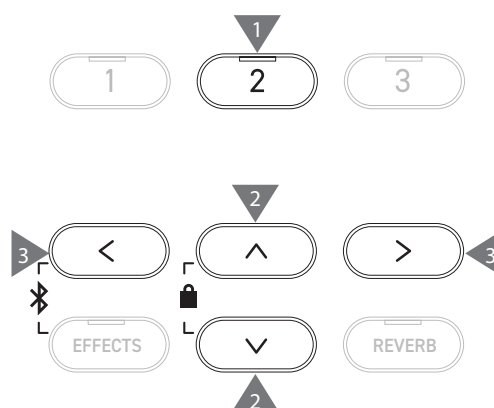

4 Speaker Volume

The Speaker Volume setting allows the maximum volume level of the digital piano's speaker output to be reduced, providing finer adjustment control over the master volume.

Speaker Volume setting

"Normal" or "Low" can be specified.

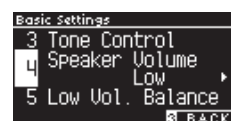

5 Low Volume Balance

The Low Volume Balance setting enhances pianissimo touches, allowing the piano to be played more naturally when the [MASTER VOLUME] slider is set to a low level.



The display shows "Low Vol. Balance".

Low Volume Balance setting

The value can be specified in the range from 1 to 5 or set to Off. Increasing the value will enhance the sound of pianissimo touches while the volume is reduced.

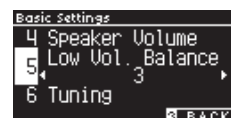

6 Tuning

The Tuning function allows players to adjust the pitch of the instrument.

Adjusting the pitch

The pitch can be adjusted in the range from 427.0 to 453.0 Hz in the unit of 0.5 Hz.



7 Damper Hold

The Damper Hold setting is used to determine whether sounds such as organ or strings should be sustained continuously when the sustain (damper) pedal is pressed, or whether these sounds should decay, naturally.

Damper Hold setting

When this setting is turned on, sustained sounds played while the damper pedal is pressed will be sustained even after hands are lifted from the keyboard.

When this setting is turned off, sustained sounds played while the damper pedal is pressed will decay after hands are lifted from the keyboard.



10 Startup Settings

The Startup Settings function allows preferred settings to be stored in memory, and automatically recalled as the default settings every time the instrument is turned on.

Settings stored in Startup Settings

- Basic Settings
- Virtual Technician settings
- Phones Settings
- MIDI Settings
- Dual settings, Split settings, and Four Hands settings
- Metronome tempo, beat, and volume settings
- Sound selected when Startup Settings are stored
- Sounds selected for each SOUND button when Startup Settings are stored
- Effects and Reverb settings for each sound when Startup Settings are stored

Executing the Startup Settings

With "Startup Settings" selected, press the [REC] button.

When the Startup Settings have been stored, the display will return to the Basic Settings screen.

11 Factory Reset

Factory Reset is a function that restores the instrument back to its factory default configuration.

Executing the Factory Reset

With "Factory Reset" selected, press the [REC] button.

When the Factory Reset is complete, the display will return to the Home screen.



Internal Recorder and Registration memories are not reset.

12 Auto Display Off

The Auto Display Off function can be used to automatically turn off the display after a specified time has elapsed.

Auto Display Off setting

The Auto Display Off setting can be set to 15 seconds, 5 minutes, or 30 minutes.

After the display has turned off, pressing any of the control buttons will turn on the display again.

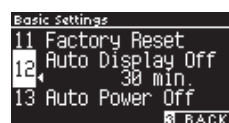

13 Auto Power Off

The Auto Power Off function can be used to automatically turn off the power after a specified period of inactivity.

Auto Power Off setting

The Auto Power Off setting can be set to Off, 15 minutes, 60 minutes or 120 minutes.



The default Auto Power Off setting varies depending on market location.

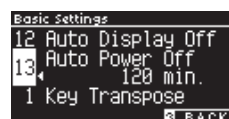

Virtual Technician

An experienced piano technician is essential to fully realise the potential of a fine acoustic piano. In addition to meticulously tuning each note, the technician also performs numerous regulation and voicing adjustments that allow the instrument to truly sing.

The Virtual Technician settings of the digital piano simulate these refinements digitally, allowing performers to shape various aspects of the instrument's character to suit their personal preferences.

Virtual Technician settings

Smart Mode	Select a pre-determined combination of piano adjustments.
Advanced Mode	Make fine adjustments to individual, voicing, touch curve, etc. parameters.

Smart Mode

Smart Mode settings

Name	Description
Normal	Default setting for Smart Mode.
Noiseless	Setting to minimise additional damper and string resonance, and mechanism noises when keys are released.
Deep Resonance	Setting to emphasise damper pedal resonance and string resonance.
Light Resonance	Setting to reduce damper pedal resonance and string resonance.
Soft	Setting to produce a softer tone by softening the hammers and increasing the touch weight of the keyboard, which is suitable for slow, quiet pieces.
Brilliant	Setting to produce a brighter tone including damper resonance by hardening the hammers, which is suitable for cheerful and elegant pieces or songs requiring good resonance.
Clean	Setting to reduce resonance by hardening the hammers and lightening the touch of keys.
Full	Setting to emphasise noises and resonance by increasing the sensitivity of the hammers, which is suitable for dynamic and powerful pieces.
Dark	Setting to add unique darkness to the tone by hardening the hammers and increasing the touch weight of keys.
Rich	Setting to emphasise the resonance by increasing the sensitivity of the hammers and lightening the touch of keys.
Historical	Setting to replicate the tone of a piano used during the Classical and Romantic eras.

Selecting the Smart Mode preset

1. On the Home screen, press the [1] button to enter the Virtual Technician screen.
2. Press the [UP]/[DOWN] button to select "Smart Mode".



3. Press the [2] button.
4. Press the [LEFT]/[RIGHT] button to set the Smart Mode type.

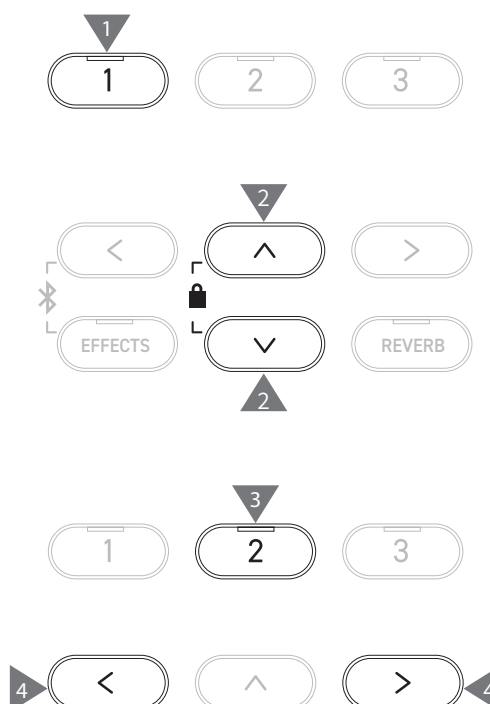

Showing the Smart Mode Help screen

In Smart Mode, press the [1] button to display descriptions of each Smart Mode preset.



Saving Smart Mode

In Smart Mode, press the [2] button to save the selected Smart Mode to the sound. The saved settings will be reapplied to the sound even after restarting the instrument.

Advanced Mode

Advanced Mode items, effective sounds, and default settings

Setting	Default	Effective sound	Page
1. Touch Curve	Normal	All sounds	P53
2. Voicing	Normal	All sounds	P54
3. Damper Resonance	5	Piano sound only	P55
4. Damper Noise	5	Piano sound only	P55
5. String Resonance	5	Piano sound only	P55
6. Undamped Str. Res.	5	Piano sound only	P56
7. Cabinet Resonance	1	Piano sound only	P56
8. Key-off Effect	5	Piano sound Tine Electric Piano Reed Electric Piano Tine Electric Piano 2 Clavi Wood Bass	P56
9. Fall-back Noise	5	Piano sound Harpsichord	P56
10. Hammer Noise	5	Piano sound only	P57
11. Hammer Delay	Off	Piano sound only	P57
12. Topboard Simulation	Open 3	Piano sound only	P57
13. Decay Time	5	All sounds	P57
14. Release Time	5	All sounds	P58
15. Minimum Touch	1	Piano sound Tine Electric Piano Reed Electric Piano Tine Electric Piano 2	P58
16. Stretch Tuning/User Tuning	(Varies by the sound)	All sounds	P58
17. Temperament	Equal Temp.	All sounds	P59
18. Temperament Key	C	All sounds	P60
19. Key Volume	Normal	All sounds	P60
20. Half-Pedal Adjust	5	All sounds	P61
21. Soft Pedal Depth	5	All sounds	P61

Selecting and adjusting the desired setting

- On the Virtual Technician screen, press the [UP]/[DOWN] button to select "Advanced Mode".



- Press the [2] button.
 - Press the [UP]/[DOWN] button to select the settings menu.
 - Press the [LEFT]/[RIGHT] button to set the value or type.
- Pressing the [LEFT]/[RIGHT] buttons simultaneously will restore the default setting.

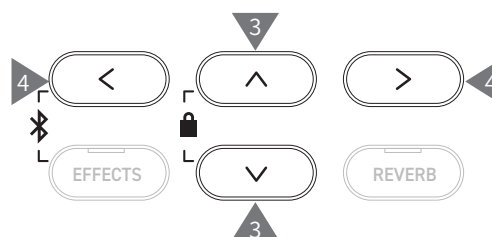
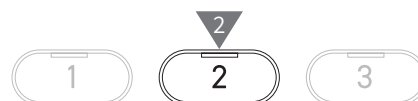
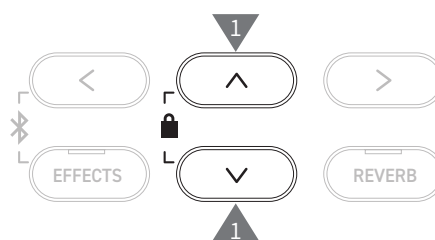

Showing the Advanced Mode Help screen

In Advanced Mode, press the [1] button to display descriptions of each setting.

Saving Advanced Mode

In Advanced Mode, press the [2] button to save types and values of Advanced Mode settings to the sound. The saved settings will be reapplied to the sound even after restarting the instrument.

1 Touch Curve

The Touch Curve function allows players to change the relationship between the volume and the strength of keystrokes.



The display shows "Touch".

Touch Curve types

Touch Curve	Description
Heavy 4	Produces a more softer sound consistently.
Heavy 3	Produces a softer sound consistently.
Heavy 2	Suitable for dynamic performances with accents.
Heavy 1	This curve makes it easier to produce soft sounds of a light hit and bright sounds of a strong hit.
Normal	Reproduces the standard touch sensitivity of an acoustic piano.
Light 1	Produces a longer volume even with a soft touch.
Light 2	Produces a more longer volume even with a soft touch.
Light 3	Produces stable sounds even if playing with a weak touch.
Light 4	This touch curve is suitable for small children and organ players.
Off	Produces the sound at a constant volume regardless of the strength of keystrokes.
User	A touch curve will be automatically created according to the force of the user's fingers playing the keyboard.

Creating a User Touch Curve

1. With "User" selected, press the [REC] button.

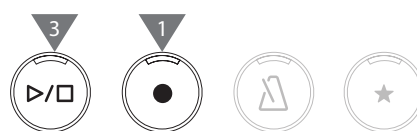
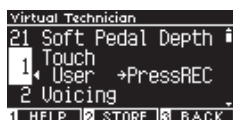

2. Play any key from very soft to very loud.
3. Press the [PLAY/STOP] button when finished.
"analysis completed" is displayed when the user touch curve is created.



- With "User" selected, pressing the [2] button will save the created Touch Curve to the selected sound.

2 Voicing

The Voicing function simulates different hammer properties, affecting the tonal character of the piano.

Hammer types

Voicing type	Description
Normal	Normal setting.
Mellow 1	Setting to produce a softer tone by softening the hammers.
Mellow 2	Setting to produce an even softer tone by further softening the hammers than Mellow 1.
Dynamic	Setting to produce a dynamic tone from soft to bright according to the touch of keys.
Bright 1	Setting to produce a brighter tone by hardening the hammers.
Bright 2	Setting to produce an even brighter tone by further hardening the hammers than Bright 1.
User	Voicing adjustment between -5 and +5 can be set on any key. -5 is the mellowest and +5 is the brightest setting.

Adjusting User Voicing

1. With "User" selected, press the [2] button.

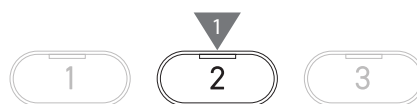

2. Press the [UP]/[DOWN] button to select the key to tune.
Or, press and hold the [2] button and press the key to tune.

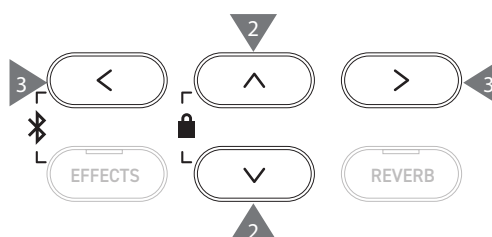

3. Press the [LEFT]/[RIGHT] button to set the value.

- With "User" selected, pressing the [1] button will save the specified value to the selected sound.

3 Damper Resonance

Damper Resonance simulates the resonance effects of the whole piano when the damper pedal is pressed.

Adjusting the Damper Resonance volume

The value can be specified in the range from 1 to 10, or can be set to "Off".

"1" is the smallest and "10" is the greatest.

When set to "Off", Damper Resonance will not be produced.



4 Damper Noise

The Damper Noise function adjusts the volume of the noise that occurs when the damper pedal is pressed.

Adjusting the Damper Noise volume

The value can be specified in the range from 1 to 10, or can be set to "Off".

"1" is the smallest and "10" is the greatest.

When set to "Off", Damper Noise will not be produced.



5 String Resonance

String Resonance simulates the resonance effects of the piano strings.

What is string resonance?

To experience the string resonance phenomenon, gently hold down the "C" key as shown in the illustration below, then play (strike and release quickly) any of the keys marked with a ● symbol. In addition to the sound of each note played, it should also be possible to hear the strings of the first "C" key resonating "sympathetically", thus demonstrating String Resonance.

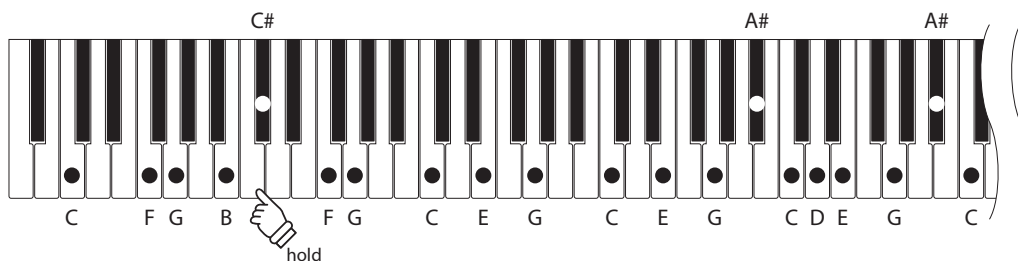

Adjusting the String Resonance volume

The value can be specified in the range from 1 to 10, or can be set to "Off".

"1" is the smallest and "10" is the greatest.

When set to "Off", String Resonance will not be produced.



6 Undamped String Resonance

Undamped String Resonance simulates the string resonance in the undamped topmost keys.



- The display shows “UndampedStr.Reso.”.
- Topmost keys of grand pianos are undamped; therefore, they are always free to vibrate regardless of whether the damper pedal is pressed or not.

Adjusting the Undamped String Resonance volume

The value can be specified in the range from 1 to 10, or can be set to “Off”.

“1” is the lightest and “10” is the deepest.

When set to “Off”, Undamped String Resonance will not be produced.



7 Cabinet Resonance

Cabinet Resonance simulates the cabinet resonance of grand pianos.

Adjusting the Cabinet Resonance volume

The value can be specified in the range from 1 to 10, or can be set to “Off”.

“1” is the lightest and “10” is the deepest.

When set to “Off”, Cabinet Resonance will not be produced.



8 Key-off Effect

Key-off Effect simulates the sound of the damper’s touching the string immediately before the sound stops.

Adjusting the Key-off Effect volume

The value can be specified in the range from 1 to 10, or can be set to “Off”.

“1” is the lightest and “10” is the deepest.

When set to “Off”, Key-off Effect will not be produced.



9 Fall-back Noise

Fall-back Noise simulates the noise from the key action when keys are released.

Adjusting the Fall-back Noise volume

The value can be specified in the range from 1 to 10, or can be set to “Off”.

“1” is the smallest and “10” is the greatest.

When set to “Off”, Fall-Back Noise will not be produced.

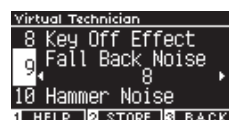

10 Hammer Noise

The Hammer Noise function allows to adjust the sound of the hammers' hitting strings and the keys' hitting the key bed when acoustic pianos are played.

Adjusting the Hammer Noise volume

The value can be specified in the range from 1 to 10, or can be set to "Off".

"1" is the smallest and "10" is the greatest.

When set to "Off", Hammer Noise will not be produced.



11 Hammer Delay

Hammer Delay simulates the slight delay of the hammers' hitting strings when acoustic pianos are played in pianissimo.

Adjusting the Hammer Delay value

The value can be specified in the range from 1 to 10, or can be set to "Off".

"1" is the smallest hammer delay and "10" is the greatest hammer delay.

When set to "Off", Hammer Delay will not be produced.



12 Topboard Simulation

Topboard Simulation simulates the difference in the sound produced by the opening of the topboard of grand pianos.

Topboard Simulation types

Topboard position	Description
Open3	Reproduce the status where the topboard is completely open.
Open2	Reproduce the status where the topboard is half open.
Open1	Reproduce the status where the topboard is slightly open.
Closed1	Reproduce the status where the topboard is closed except the front lid.
Closed2	Reproduce the status where the topboard is completely closed.

13 Decay Time

The Decay Time function allows to adjust the duration of the sound decay after keys are pressed.

Adjusting the Decay Time volume

The value can be specified in the range from 1 to 10.

"1" is the shortest decay and "10" is the longest decay.



14 Release Time

The Release Time function allows to adjust the duration of the sound decay after keys are released.

Adjusting the Release Time volume

The value can be specified in the range from 1 to 10.
"1" is the shortest decay and "10" is the longest decay.



15 Minimum Touch

The Minimum Touch function allows to set the touch sensitivity for the quietest sound.

Adjusting the Minimum Touch value

The value can be specified in the range from 1 to 20.
"1" is the smallest Minimum Touch that produces a sound even by an extremely soft touch.
"20" is the greatest Minimum Touch that produces no sound for an extremely soft touch.



16 Stretch Tuning/User Tuning

The Stretch Tuning function allows a piano-specific tuning which makes lower octaves slightly flatter and upper octaves slightly sharper than the normal equal temperament. This function is available only when equal temperament is selected for the temperament type. In addition, User Tuning allows individual tuning for each of the 88 keys.



The display shows "Stretch/UserTuning".

Stretch Tuning types

Stretch Tuning	Description
Off	Normal equal temperament tuning.
Normal	Lower octaves are slightly flatter and upper octaves are slightly sharper than the normal equal temperament.
Wide	Lower octaves are flatter and upper octaves are sharper than the normal equal temperament.
User	Tuning range between -50 and +50 can be set on each key.

User Tuning settings

1. With "User" selected, press the [2] button.



2. Press the [UP]/[DOWN] button to select the key to tune. Or, press and hold the [2] button and press the key to tune.



3. Press the [LEFT]/[RIGHT] button to set the value.

- With "User" selected, pressing the [1] button will save the specified value to the selected sound.

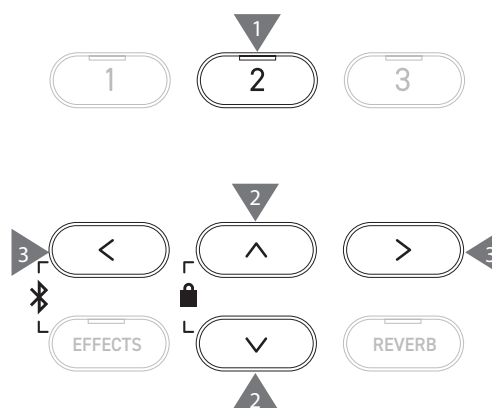

17 Temperament

In addition to the most common equal temperament, this instrument can be set with early tuning systems used in the Renaissance and Baroque eras.

Temperament types

Temperament type	Description
Equal Temperament (Equal)	The most common tuning system for the modern pianos. This allows the consistent harmonies regardless of modulations and transpositions.
Pure Temperament (Pure Major/Pure Minor)	The tuning system that eliminated impurity from the most important third and fifth intervals. Therefore, third and fifth sound pure; however, other intervals may sound impure. Use this system by specifying the tonic of the piece to be played.
Pythagorean Temperament (Pythagorean)	The tuning system that eliminated impurity from most of fifth intervals. Although chords sound impure due to the impurity in third intervals, the system brings out the character of melodies.
Meantone Temperament (Meantone)	The tuning system that incorporated slight impurity in fifth intervals in order to eliminate impurity from the most important major third intervals. This system was commonly used for early keyboard music.
Werckmeister Temperament (Werckmeister) Kirnberger Temperament (Kirnberger)	This tuning system makes keys with fewer key signatures sound closer to the Meantone Temperament which produces chords purer, and keys with more key signatures sound closer to the Pythagorean Temperament which brings out the character of melodies. This reflects the "character of keys" intended by the classical composers.
User Temperament (User)	The original temperament can be set between -50 and +50 cents.  100 cents = Semi-tone

User Temperament settings

1. With "User" selected, press the [2] button.



2. Press the [UP]/[DOWN] button to select the sound to tune.

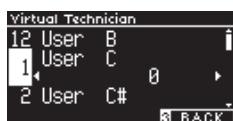

3. Press the [LEFT]/[RIGHT] button to set the value.

- With "User" selected, pressing the [1] button will save the specified value to the selected sound.

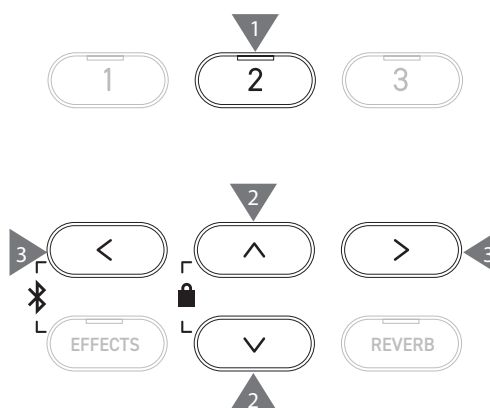

18 Temperament Key

Temperaments apart from the equal temperament are specific to the key. The Temperament Key function adjusts the temperament to the specified tonic of the song to be played.

Selecting Temperament Key

The value can be specified in the range from C to B.

The temperament does not change if the equal temperament is specified even when the tonic is set.



19 Key Volume

The Key Volume function allows players to adjust the volume of each of the 88 keys.

Key Volume types

Key Volume	Description
Normal	The default setting for the 88-key volume.
High Damping	The volume is gradually reduced towards the upper sound range.
Low Damping	The volume is gradually reduced towards the lower sound range.
High & Low Damping	The volume is gradually reduced towards the upper and lower sound range.
Center Damping	The volume is gradually reduced towards the center of the keyboard.
User	The volume can be set between -50 and +50 for each of 88 keys.

User Key Volume settings

- With "User" selected, press the [2] button.



- Press the [UP]/[DOWN] button to select the key to adjust the volume.
Or, press and hold the [2] button and press the key to adjust the volume.



- Press the [LEFT]/[RIGHT] button to set the value.

- With "User" selected, pressing the [1] button will save the specified value to the selected sound.

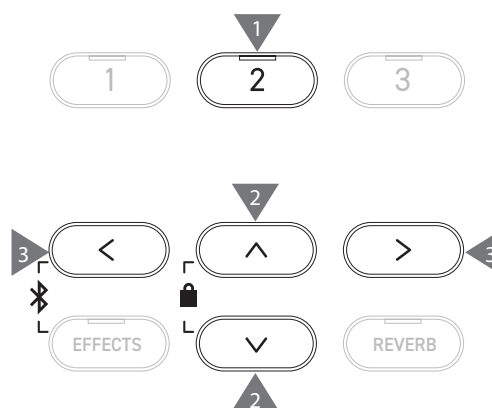

20 Half-Pedal Adjust

The Half-Pedal Adjust function allows the point at which the damper pedal becomes effective (i.e. when the dampers of the piano begin to lift from the strings) to be adjusted.

Adjusting the Half-Pedal Adjust value

Value	Description
1	This setting allows Half-Pedal to take effect at a shallow point.
⋮	
7	This setting allows Half-Pedal to take effect at a deep point.
8	This setting is intended for using the pedal as a MIDI controller. The maximum value will be reached when the damper pedal is pressed slightly.
⋮	
10	This setting is intended for using the pedal as a MIDI controller. The maximum value will be reached when the damper pedal is pressed fully.



21 Soft Pedal Depth

The Soft Pedal Depth function allows adjustment of effectiveness of the soft pedal.

Adjusting the Soft Pedal Depth value

The value can be specified in the range from 1 to 10. The effect of the Soft Pedal is the lightest with "1", and the greatest with "10".



Phones Settings

Phones Settings

Setting	Description	Default setting
Spatial Headphone Sound	Special Headphone Sound (SHS) is a feature that enhances the depth and realism of the acoustic piano sound through earphones or headphones. This feature also reduces auditory discomfort and fatigue when using headphones or earphones for extended periods of time.	Normal
Phones Type	The Phones Type setting optimises the sound of the instrument when listening through different types of headphones or earphones.	Normal
Phones Volume	The Phones Volume setting allows the maximum volume level of the headphones output to be increased.	Normal

Entering the Phones Settings screen

- On the Settings Menu screen, press the [UP]/[DOWN] button to select "Phones Settings".



- Press the [2] button to enter the Phones Settings screen.
- Press the [UP]/[DOWN] button to select the function to use.

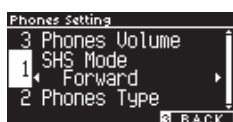

- Press the [LEFT]/[RIGHT] button to set the value or type.
- Pressing the [LEFT]/[RIGHT] buttons simultaneously will restore the default setting.

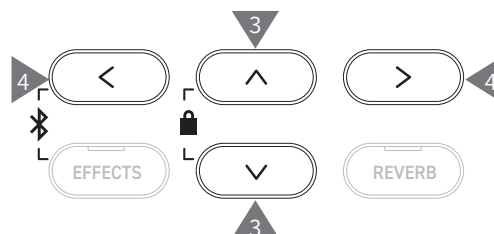
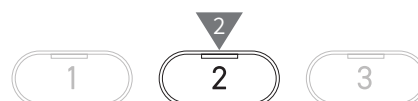
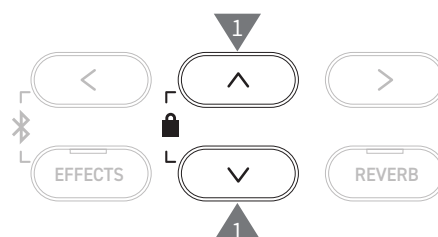

1 Spatial Headphone Sound



The display shows "SHS Mode".

Spatial Headphone Sound types

Type	Description
Off	Disables the Spatial Headphone Sound feature.
Forward	Provides front focuses, somewhat narrow spatial positioning.
Normal	Provides naturally balanced spatial positioning that is neither forward nor wide.
Wide	Provides wide, very open spatial positioning.

2 Phones Type

■ Phones type settings

Type	Description
Normal	Disables the headphone optimisation.
Open	Optimises the sound for open-type headphones.
Semi-Open	Optimises the sound for semi-open type headphones.
Closed	Optimises the sound for closed-type headphones.
Inner-ear	Optimises the sound for inner-ear type headphones.
Canal	Optimises the sound for canal-type headphones.

3 Phones Volume

■ Changing the Phones Volume type

“Normal” or “High” can be specified.



Using headphones at high volume levels for extended periods of time may result in hearing loss.

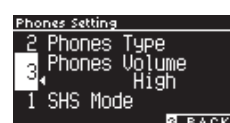

USB Menu

■ Compatible USB devices

Flash memory with USB support (USB memory devices) can be used. Any other USB devices (mouse, keyboard, hub, etc.) cannot be used even if they are connected.

■ Connecting a USB memory device

Insert the plug compatible to the [USB to DEVICE] port in the correct way taking care it is not upside down. Connect the USB memory device directly without using a USB extension cable. The “USB to Device” functionality of this instrument conforms to USB2.0 Hi-Speed standards. Older USB devices can still be used, however data transfer speed will be limited to the maximum transfer speed of the device. Connecting a USB memory device allows saving data created on this instrument into the USB memory and playing back the data in the USB memory on this instrument.

■ Formatting a USB memory device

Some USB memory devices require formatting before they can be used with this instrument. If a message appears to prompt for formatting the device after connecting the USB memory device to the [USB to DEVICE] port, check that the USB memory device does not contain any necessary data, and format the device.

P76 Format USB

Contents of the USB memory device are erased after formatting. The USB memory device may contain data used by other devices which is not displayed on this instrument. Take care when formatting a device.

■ Inserting and removing a USB memory device

Check that the USB memory device is not being accessed such as data being saved, copied, or deleted, or the device being formatted before removing the USB memory device.



If a USB memory device is inserted while the instrument is turned on, some devices may take a while before they can be played; however, this is not a fault.

■ Checking connection of a USB memory device

A USB icon appears in the display while a USB memory device is connected to the instrument.

P13 Home screen

■ USB Menu functions

Function	Description	Page
1. Load Song	Load a song file (KSO file) from a USB memory device into the instrument's internal memory.	P66
2. Load Registration All	Load the registration file (All/KM3 file) from a USB memory device into the instrument's internal memory.	P67
3. Load Registration Single	Load the registration file (Single/KM6 file) from a USB memory device into the instrument's internal memory.	P68
4. Load Startup Setting	Load a startup setting file (KM1 file) from a USB memory device into the instrument's internal memory.	P69
5. Save Internal Song	Save the song recorded in the instrument's internal memory to a USB memory device in KSO file format.	P70
6. Save SMF Song	Save the song recorded in the instrument's internal memory to a USB memory device in SMF file format.	P71
7. Save Registration All	Save all of the registrations set on the instrument to a USB memory device in KM3 file format.	P72
8. Save Registration Single	Save a registration set on the instrument to a USB memory device in KM6 file format.	P73
9. Save Startup Setting	Save the startup setting set on the instrument to a USB memory device in KM1 file format.	P74
10. Rename File	Rename a file in a USB memory device.	P75
11. Delete File	Delete a file in a USB memory device.	P76
12. Format USB	Format a USB memory device.	P76

■ Entering the USB Menu screen

1. On the Settings Menu screen, press the [UP]/[DOWN] button to select "USB Menu".



2. Press the [2] button to enter the USB Menu screen.
3. Press the [UP]/[DOWN] button to select the item to use.

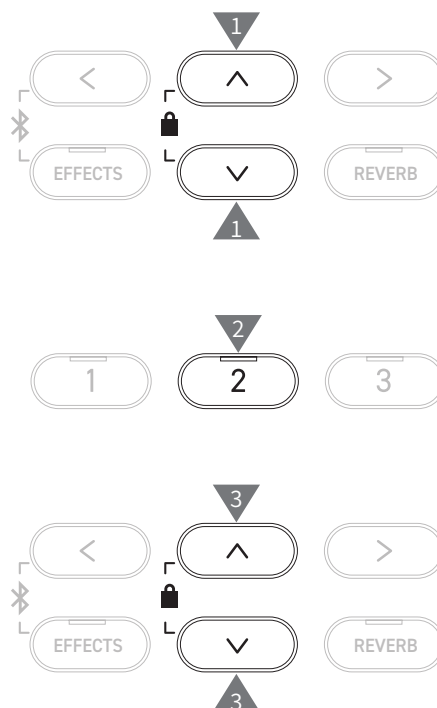
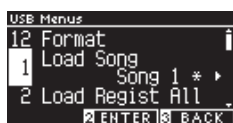

Loading and saving USB Menu

Song

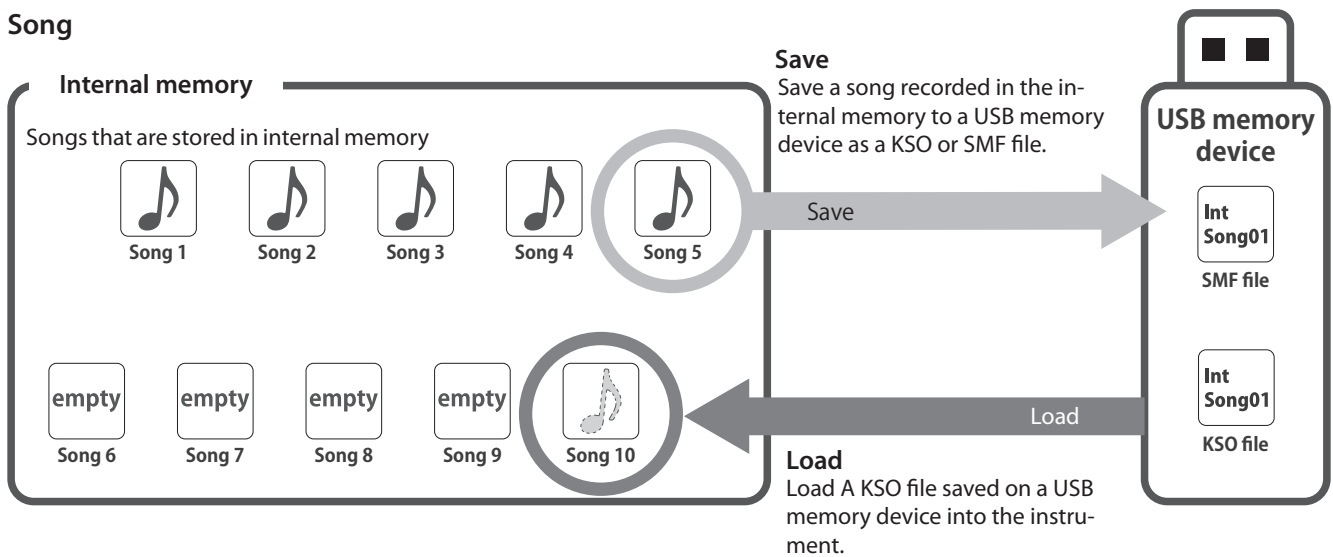

Registration/Startup Settings

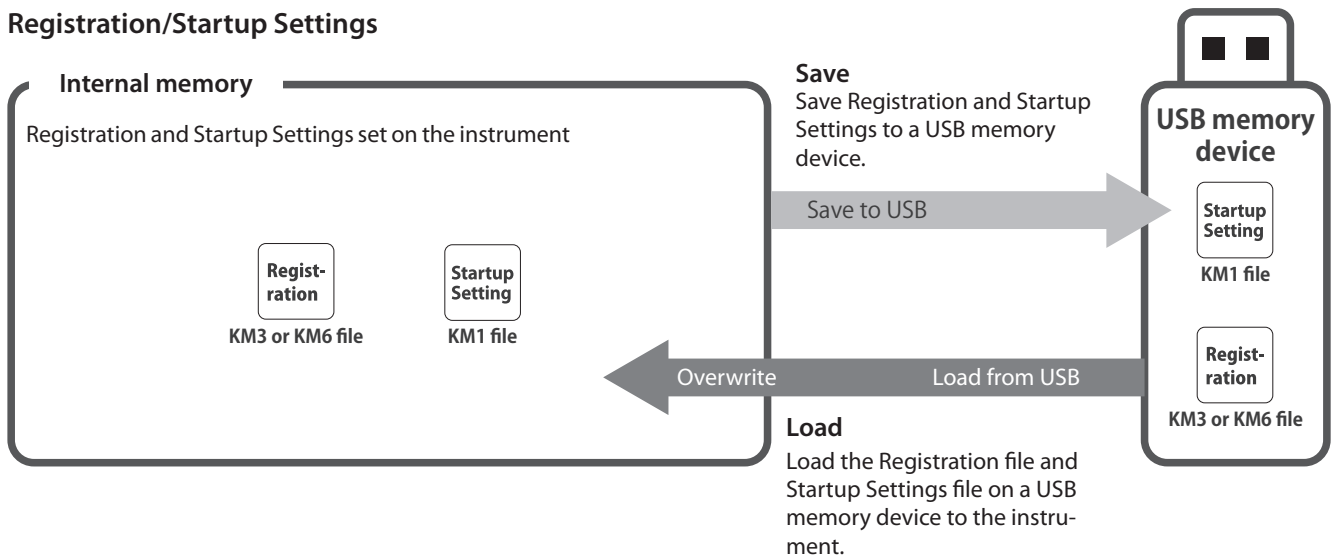

1 Load Song

Loading

1. With "Load Song" selected, press the [LEFT]/[RIGHT] button to select the internal song memory for the song to be loaded into.

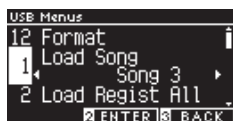

Songs are loaded into the memory that is used for recording up to 10 songs.

2. Press the [2] button.
3. Press the [UP]/[DOWN] button to select the song to load.

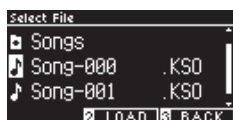

4. Press the [2] button.
5. Press the [1] button to load, or press the [3] button to cancel.

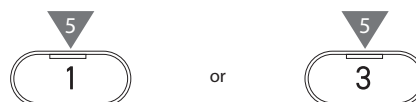
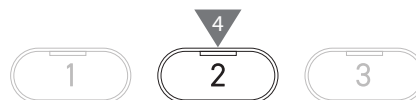
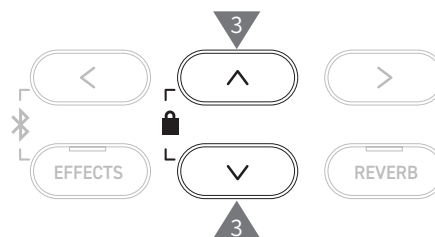
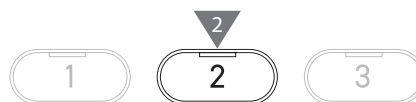
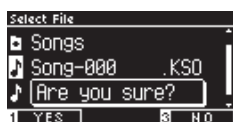

2 Load Registration All



The display shows "Load Regist All".

Type of registration files

Type	Description	Extension
Single	Stores a single registration.	KM6
All	Stores all of 16 registrations.	KM3

Loading

- With "Load Regist All" selected, press the [2] button.

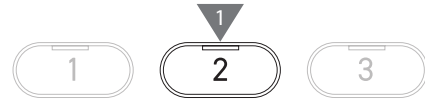
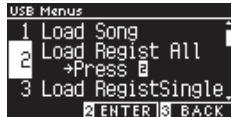

- Press the [UP]/[DOWN] button to select a registration file (type All) [.KM3] to be loaded.

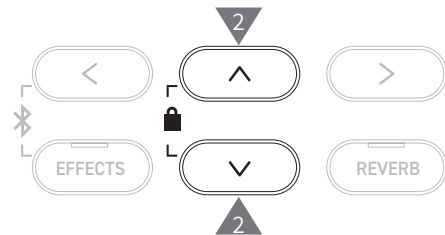

- Press the [2] button.
- Press the [1] button to load, or press the [3] button to cancel.

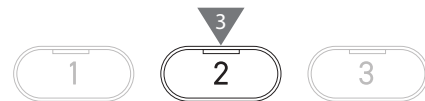
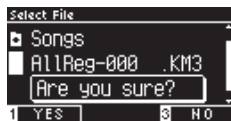

The extension of the type All registration file is "KM3".
The file is not compatible with other models.

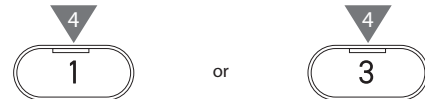

Registrations set on the instrument will be all overwritten when the Load Registration All function is executed. Check carefully before using this function.

3 Load Registration Single



The display shows "Load RegistSingle".

Loading

- With "Load RegistSingle" selected, press the [LEFT]/[RIGHT] button to select the registration memory for the registration to be loaded into.



- Press the [2] button.
- Press the [UP]/[DOWN] button to select the registration file (type Single) [.KM6] to be loaded.



- Press the [2] button.
- Press the [1] button to load, or press the [3] button to cancel.

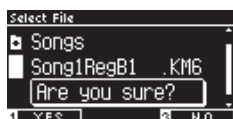

The extension of the type Single registration file is "KM6".

The file is not compatible with other models.

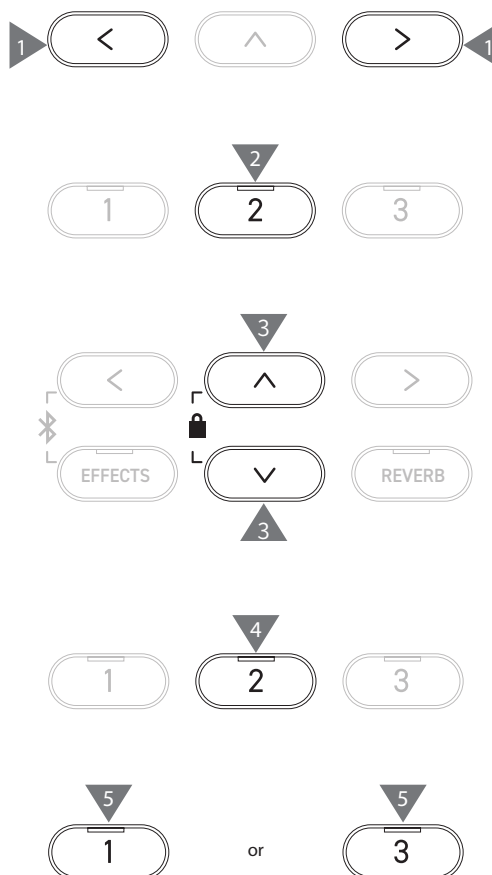

4 Load Startup Setting



The display shows "Load Startup Set."

Loading

- With "Load Startup Set." selected, press the [2] button.

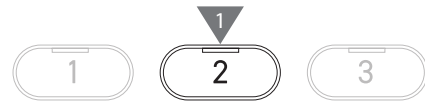

- Press the [UP]/[DOWN] button to select the startup settings file [.KM1] to be loaded.

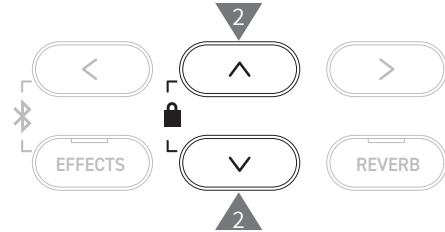

- Press the [2] button.
- Press the [1] button to load, or press the [3] button to cancel.

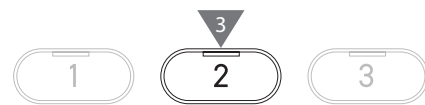
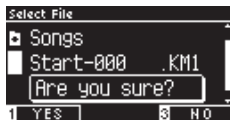

The extension of the startup settings file is "KM1".
The file is not compatible with other models.

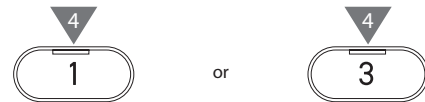

The startup settings configuration previously stored to memory will be deleted when the Load Startup Setting function is executed.

5 Save Internal Song



The display shows "Save Song(INT)".

■ Saving

1. With "Save Song(INT)" selected, press the [LEFT]/[RIGHT] button to select a song to be saved.



2. Press the [2] button.
3. Specify the name for the song to be saved to the USB memory device.

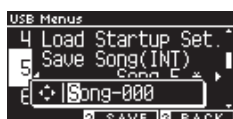

Press the [LEFT]/[RIGHT] button to move the cursor and press the [UP]/[DOWN] button to change characters.

Up to 12 characters can be specified for the file name.

4. Press the [2] button after entering the file name.
5. Press the [1] button to save, or press the [3] button to cancel.



In the case where a file with the same name already exists, specify whether to overwrite it.

Press the [1] button to overwrite, or press the [3] button to specify another name.

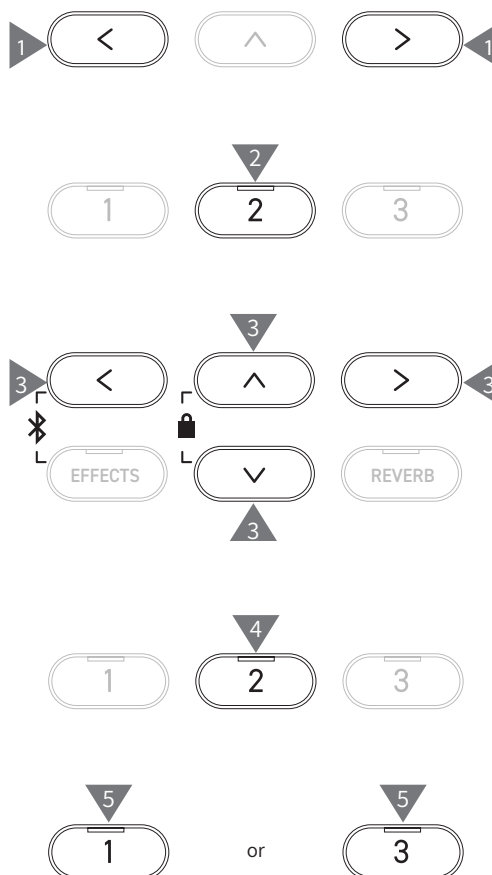

The song file will be saved in the root folder of the USB memory device.

It is not possible to save the file in a different folder.

The song may become unloadable to the instrument if the saved song is renamed by another device such as a PC.

The extension of the saved file is "KSO".

Files (*.KSO) that have been saved by USB Save Song (INT) can be loaded into any one of the ten song memories available on the instrument.

P66 Load Song

6 Save SMF Song



The display shows "Save Song(SMF)".

■ Saving

1. With "Save Song(SMF)" selected, press the [LEFT]/[RIGHT] button to select a song to be saved.



2. Press the [2] button.
3. Specify the name for the song to be saved to the USB memory device.

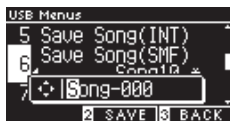

Press the [LEFT]/[RIGHT] button to move the cursor and press the [UP]/[DOWN] button to change characters.

Up to 12 characters can be specified for the file name.

4. Press the [2] button after entering the file name.
5. Press the [1] button to save, or press the [3] button to cancel.

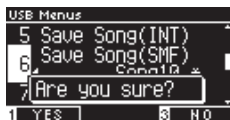

In the case where a file with the same name already exists, specify whether to overwrite it.

Press the [1] button to overwrite, or press the [3] button to specify another name.

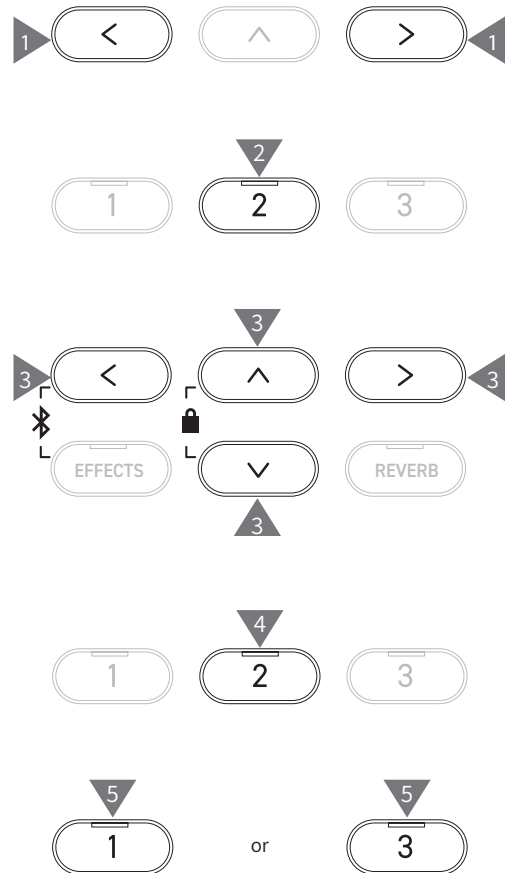

The song file will be saved in the root folder of the USB memory device. It is not possible to save the file in a different folder. The extension of the saved song file is "MID". Files (*.MID) that have been saved by Save Song (SMF) cannot be loaded into the instrument's internal song memories.

P70 Use Save Internal Song to load songs into the ten song memories available on the instrument.

7 Save Registration All



The display shows "Save Regist All".

Type of registration files

Type	Description	Extension
Single	Stores a single registration.	KM6
All	Stores all of 16 registrations.	KM3

Saving

- With "Save Regist All" selected, press the [2] button.

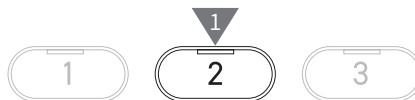
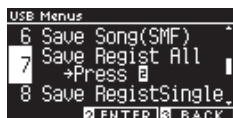

- Specify the name for the file to be saved to the USB memory device.

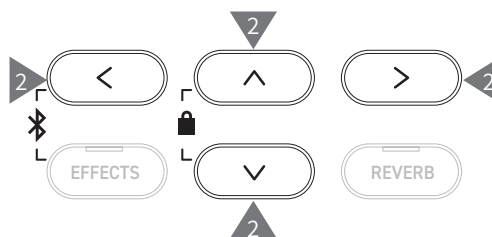

Press the [LEFT]/[RIGHT] button to move the cursor and press the [UP]/[DOWN] button to change characters.

Up to 12 characters can be specified for the file name.

- Press the [2] button after entering the file name.
- Press the [1] button to save, or press the [3] button to cancel.

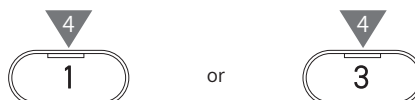
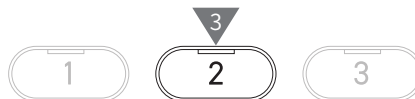
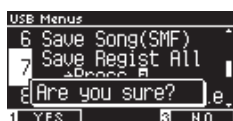

In the case where a file with the same name already exists, specify whether to overwrite it.

Press the [1] button to overwrite, or press the [3] button to specify another name.



The song file will be saved in the root folder of the USB memory device.
It is not possible to save the file in a different folder
The file saved by Save Registration All is not compatible with other models.

8 Save Registration Single



The display shows "Save RegistSingle".

■ Saving

1. With "Save RegistSingle" selected, press the [LEFT]/[RIGHT] button to select the registration to be saved from A1 to B8.



2. Press the [2] button.
3. Specify the name for the file to be saved to the USB memory device.

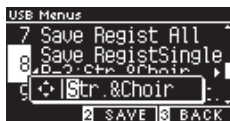

Press the [LEFT]/[RIGHT] button to move the cursor and press the [UP]/[DOWN] button to change characters.

Up to 12 characters can be specified for the file name.

4. Press the [2] button after entering the file name.
5. Press the [1] button to save, or press the [3] button to cancel.

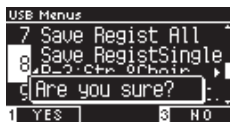

In the case where a file with the same name already exists, specify whether to overwrite it.

Press the [1] button to overwrite, or press the [3] button to specify another name.



The song file will be saved in the root folder of the USB memory device.
It is not possible to save the file in a different folder.
The file saved by Save Registration Single is not compatible with other models.

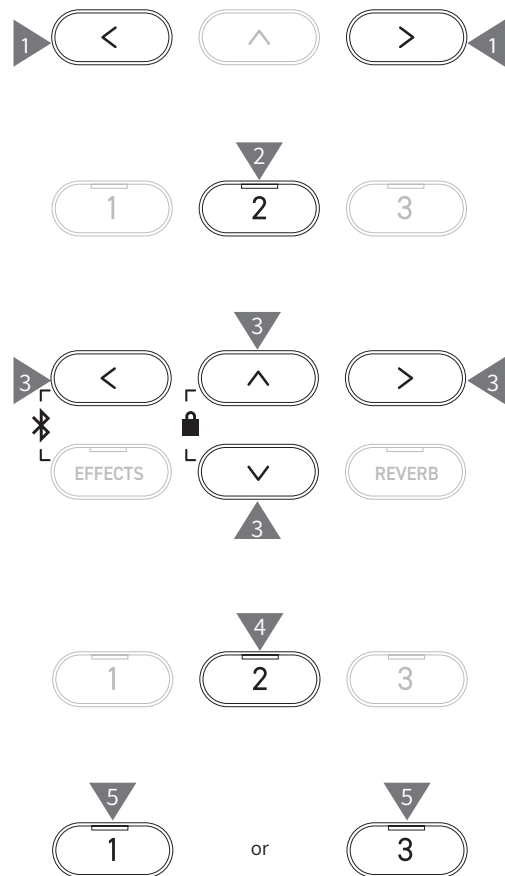

9 Save Startup Setting



The display shows "Save Startup Set."

■ Saving

1. With "Load Startup Set." selected, press the [2] button.

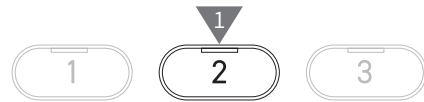

2. Specify the name for the file to be saved to the USB memory device.

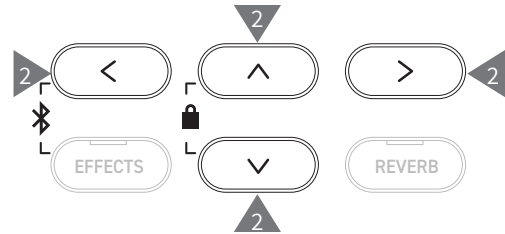

Press the [LEFT]/[RIGHT] button to move the cursor and press the [UP]/[DOWN] button to change characters.

Up to 12 characters can be specified for the file name.

3. Press the [2] button after entering the file name.
4. Press the [1] button to save, or press the [3] button to cancel.

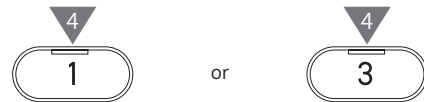
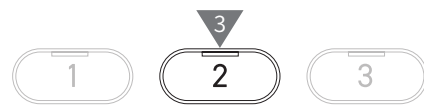

In the case where a file with the same name already exists, specify whether to overwrite it.

Press the [1] button to overwrite, or press the [3] button to specify another name.



The song file will be saved in the root folder of the USB memory device.
It is not possible to save the file in a different folder.
The extension of the startup settings file is "KM1".
The startup settings file "*.KM1" is not compatible with other models.

10 Rename File

Characters that can be used

0-9 | A-Z | a-z | ! | # | \$ | % | & | ' | (|) | + | , | - | . | ; | = | @ | [|] | ^ | _ | ` | { | }

Renaming a file

1. With "Rename" selected, press the [2] button.

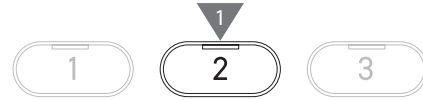

2. Press the [UP]/[DOWN] button to select the file to be renamed.

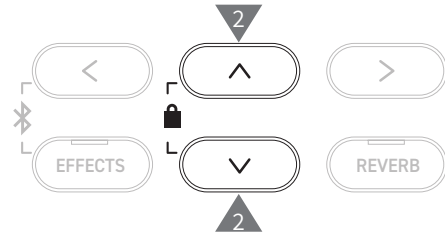

3. Press the [2] button.
4. Enter the new name.

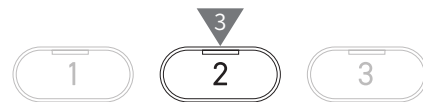

Press the [LEFT]/[RIGHT] button to move the cursor and press the [UP]/[DOWN] button to change characters.

Up to 12 characters can be specified for the file name.

5. Press the [2] button after entering the file name.
6. Press the [1] button to save, or press the [3] button to cancel.

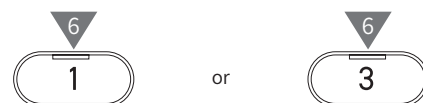
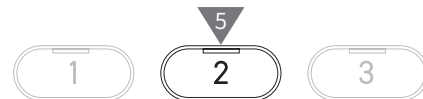
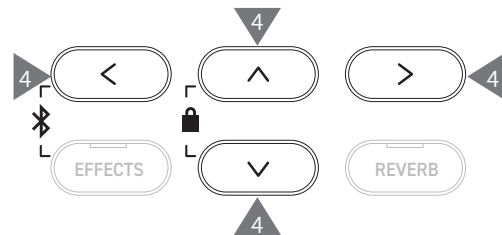

11 Delete File

Deleting a file

1. With "Delete" selected, press the [2] button.

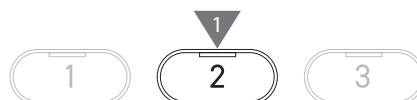
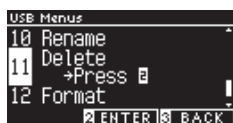

2. Press the [UP]/[DOWN] button to select the file to be deleted.

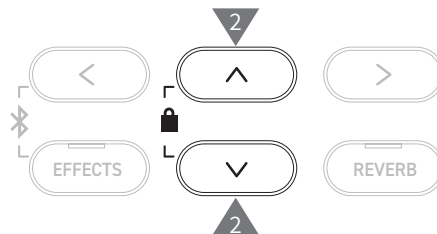

3. Press the [2] button.
4. Press the [1] button to delete, or press the [3] button to cancel.

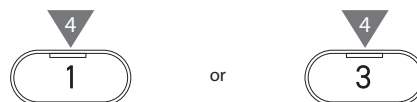
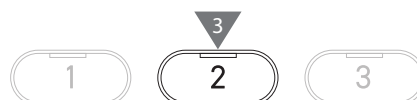

12 Format USB

Formatting

1. With "Format" selected, press the [2] button.

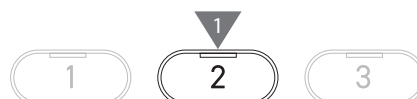
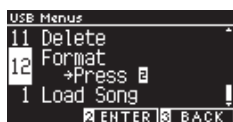

2. Press the [1] button to format, or press the [3] button to cancel.

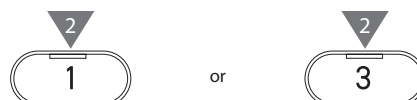

Bluetooth Settings

✓ Availability of Bluetooth function dependent on market location.

Bluetooth Settings

Type	Description	Connection method
Bluetooth MIDI	When using a smart device app that supports Bluetooth MIDI, this function allows the instrument to be controlled by an app, or send/receive MIDI data wirelessly.	Enable the smart device's Bluetooth function, launch an app that supports Bluetooth MIDI, then select "CN301 MIDI" from the app's connection setting screen.
Bluetooth Audio	This function allows audio from the connected smart device (such as songs, videos, etc.) to be played through the instrument's speakers wirelessly.	Enable the smart device's Bluetooth function, then select "CN301 Audio" from the device's Bluetooth connection setting screen. If "CN301 Audio" does not appear, press and hold the [LEFT] and [EFFECTS] buttons on the instrument's control panel while the Home screen is shown in the display. After pairing successfully, the instrument will automatically reconnect to the smart device when the power is turned on.

✓

- For more detailed instructions regarding Bluetooth pairing, please refer to the supplementary Bluetooth® Connectivity Guide manual, available from the Kawai Global website: <https://www.kawai-global.com/support/manual>.
- Only one smart device can be connected to the piano's Bluetooth MIDI or Bluetooth audio at a time.

Entering the Bluetooth Settings screen

1. On the Settings Menu screen, press the [UP]/[DOWN] button to select "Bluetooth Settings".



2. Press the [2] button to enter the Bluetooth Settings screen.
3. Press the [UP]/[DOWN] button to select the type to use.

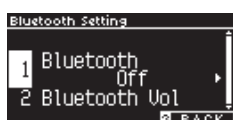

4. Press the [LEFT]/[RIGHT] button to set the value.

- Pressing the [LEFT]/[RIGHT] buttons simultaneously will restore the default setting.

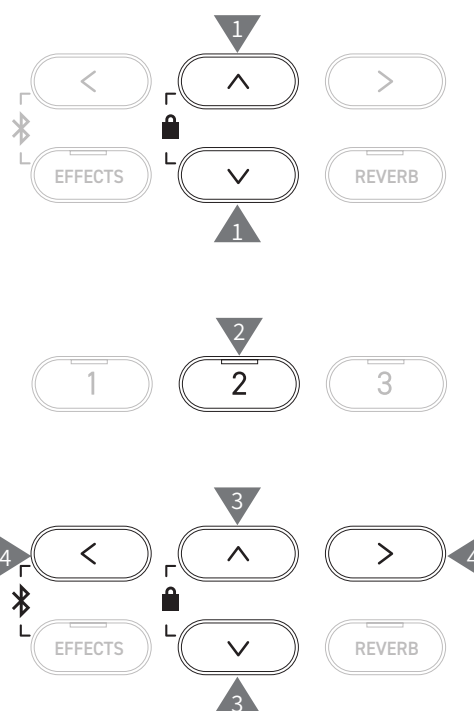

1 Bluetooth

Bluetooth settings

This function can be turned on and off.

Turn on the Bluetooth function of this instrument and enable Bluetooth communications of the smart device application near the instrument.

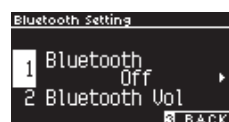

2 Bluetooth Audio Volume

This function allows players to adjust the volume of music stored in smart devices, which is output from the instrument's speakers.

After adjusting the volume on the smart device or using the [MASTER VOLUME] slider, this function can be used to fine tune the volume.



The display shows "Bluetooth Vol".

Adjusting the Bluetooth Audio Volume

The value can be adjusted in the range from -15 to +15.



Troubleshooting

Power (Settings)

Problem	Possible Cause and Solution	Page
The instrument does not turn on.	Check to see if the main connector of this instrument, AC adaptor, and power outlet are properly connected.	P13
The instrument turned itself off all of a sudden. The instrument turned off by itself.	Check to see if the "Auto Power Off" function is not enabled.	P50
The display turned off all of a sudden.	When the time to turn off the display is specified in the "Auto Display Off" function, the display will automatically turn off after the preset time. Pressing any of the control buttons will turn on the display again.	P50

Sound/Performance

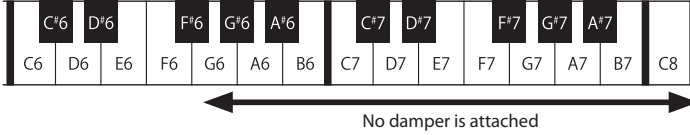
Problem	Possible Cause and Solution	Page
No sound is coming out.	<ul style="list-style-type: none"> • Check to see whether the volume has been set to the lowest level. • Check to see whether a pair of headphones or a headphone conversion plug have been connected to the [PHONES] jacks. • Check to see whether "Local Control" has been turned off. 	P14
Sounds get distorted in certain performances or at specific ranges.	For some performances, increasing the volume may cause the sound to be distorted. If this happens, reduce the volume.	P14
The pitch or sound quality of certain piano tones is odd.	The built-in piano tones are designed to reproduce the tones created by an acoustic grand piano as accurately as possible. Since the pianos produce a rich variety of resonance, the way the sound is perceived changes depending on the location or environment. The way the sound is perceived also changes when a single key is pressed and when the same key is pressed in the flow of a song. For this reason, strong overtones may be heard in some ranges, or the pitch and sound quality may seem odd. But this is normal.	
The volume is different for each key.	Adjust the volume of keys as needed in the Key Volume setting.	P60
Some keys are out of tune.	Adjust these keys using User Tuning.	P59
There is a noise or metallic sound.	Adjust using Tone Control, Fall-back Noise, and/or Damper Noise.	P48 P56 P55
Sound is muffled, or piercing.	Adjust using Topboard Simulation, Tone Control, Touch Curve, and/or Voicing.	P48 P53 P54
There is a noise when releasing keys.	Adjust Fall-back Noise and/or Key-off Effect.	P56 P56
The high frequency notes sustain longer even when the damper pedal is not pressed.	<p>This is normal.</p> <p>The highest keys on an acoustic piano (shown below) are not equipped with the sound suppressor dampers.</p> <p>This instrument replicates this behaviour precisely and allows the sound of the keys without dampers to sustain longer even when the damper pedal is not pressed.</p> 	
The pedal does not work at all, or it does not produce the same effect each time.	Check to see if the pedal cable is properly connected to the instrument. Even when they are connected, try unplugging the cable and inserting it again to make sure.	

Problem	Possible Cause and Solution	Page
The pedals are unstable.	Check that the adjuster is set to an appropriate height.	P12
There is a noise when pressing the pedal.	A sound of undamped strings occurs when the damper pedal is pressed regardless of whether keys are pressed or not. This is not a fault.	

Connection

Problem	Possible Cause and Solution	Page
The instrument is unable to connect to a smart device.	<ul style="list-style-type: none"> • Check to see if the instrument's Bluetooth function is enabled. • Use the application's settings to connect, instead of the Bluetooth setting of the smart device. 	P78
Connection fails for the paired smart device.	If the connection gets cut off immediately after pairing, turn off the Bluetooth setting on the smart device and turn it back on, then try connecting the device again.	P78
The name of the piano does not appear in the smart device.	It's possible that another device is connected to the piano's Bluetooth MIDI/Bluetooth Audio. Press and hold the [LEFT] button and [EFFECTS] button on the Home screen to cancel pairing.	P77
Unable to send recorded performance of built-in songs.	Recorded performances of built-in songs will not output from Bluetooth MIDI.	

Playing back a song

Problem	Possible Cause and Solution	Page
The playback of a lesson song does not start.	Select a song and then press the [PLAY/STOP] button.	P37
No sound is coming out when playing back a song (MP3 or WAV).	Check that the volume of the USB Recorder is not 0.	
Cannot play back songs saved in a USB memory device.	The data format may be incompatible. Transfer speed of the USB memory device may be too slow for playing back audio files. Try another USB memory device that supports USB2.0 Hi-Speed.	P17
The volume of the MP3 or WAV audio file is too quiet, or too loud (distorted).	Adjust the recording level setting.	P21
Unintended sound comes out when playing back an SMF file. No sound is coming out when playing back an SMF file.	This instrument is not GM compatible. Therefore, the file may be played with different sounds from GM devices or not played at all depending on the sounds. This is not a fault.	

Internal Songs List

Sound/Demo Songs List

PIANO1 Piano 1		
Sound Name	Song Title	Composer
SK-EX Concert Grand Piano Concert	La Campanella	Liszt
EX Concert Grand Piano Concert	Hungarian Rhapsody No. 6	Liszt
SK-5 Grand Piano Classic	Lieder Ohne Worte No.18 "Duetto"	Mendelssohn
SK-EX Concert Grand Piano Jazz	Original	Kawai
EX Concert Grand Piano Standard	Petit chien	Chopin
SK-EX Concert Grand Piano Mellow	Sonata No.30 Op.109	Beethoven
EX Concert Grand Piano Mellow	La Fille aux Cheveux de lin	Debussy

PIANO2 Piano 2		
Sound Name	Song Title	Composer
Upright Piano Classic	Alpenglühén	Oesten
EX Concert Grand Piano Pop	Original	Kawai
SK-5 Grand Piano Pop	—	—
Upright Piano Boogie	—	—
EX Concert Grand Piano Modern	Original	Kawai
Upright Piano Honky Tonk	—	—

E.PIANO Electric Piano		
Sound Name	Song Title	Composer
Tine Electric Piano	Original	Kawai
Reed Electric Piano	—	—
Modern Electric Piano	Original	Kawai
Tine Electric Piano 2	—	—
Modern Electric Piano 2	Original	Kawai

ORGAN Organ		
Sound Name	Song Title	Composer
Jazz Organ	Original	Kawai
Blues Organ	Original	Kawai
Ballad Organ	—	—
Gospel Organ	—	—
Church Organ	Chorale Prelude "Wachet auf, ruft uns die Stimme."	Bach
Diapason	Wohl mir, daß ich Jesum habe	Bach
Diapason Octave	—	—
Principal Octave	—	—

HARPSI Harpsi & Mallets		
Sound Name	Song Title	Composer
Harpsichord	French Suite No.6	Bach
Clavi	Original	Kawai
Vibraphone	Original	Kawai
Marimba	—	—
Celesta	—	—



Strings

Sound Name	Song Title	Composer
Slow Strings	Original	Kawai
String Pad	Original	Kawai
Warm Strings	—	—
String Ensemble	Le quattro stagioni La primavera	Vivaldi



Vocal & Pad

Sound Name	Song Title	Composer
Choir	Londonderry Air	Irish folk song
Choir 2	Original	Kawai
New Age Pad	Original	Kawai
Atmosphere	Original	Kawai



Bass & Guitar

Sound Name	Song Title	Composer
Wood Bass	Original	Kawai
Electric Bass	Original	Kawai
Fretless Bass	Original	Kawai
Wood Bass & Ride	Original	Kawai
Ballad Guitar	Original	Kawai
Pick Nylon Guitar	Original	Kawai

Drum Rhythm List

No.	Rhythm Name
1	8 Beat 1
2	8 Beat 2
3	8 Beat 3
4	16 Beat 1
5	16 Beat 2
6	16 Beat 3
7	16 Beat 4
8	16 Beat 5
9	16 Beat 6
10	Rock Beat 1
11	Rock Beat 2
12	Rock Beat 3
13	Hard Rock
14	Heavy Beat
15	Surf Rock
16	2nd Line
17	50 Ways
18	Ballad 1
19	Ballad 2
20	Ballad 3
21	Ballad 4
22	Ballad 5
23	Light Ride 1
24	Light Ride 2
25	Smooth Beat
26	Rim Beat
27	Slow Jam
28	Pop 1
29	Pop 2
30	Electro Pop 1
31	Electro Pop 2
32	Ride Beat 1
33	Ride Beat 2
34	Ride Beat 3
35	Ride Beat 4
36	Slip Beat
37	Jazz Rock
38	Funky Beat 1
39	Funky Beat 2
40	Funky Beat 3
41	Funk 1
42	Funk 2
43	Funk 3
44	Funk Shuffle 1
45	Funk Shuffle 2
46	Buzz Beat
47	Disco 1
48	Disco 2
49	Hip Hop 1
50	Hip Hop 2

No.	Rhythm Name
51	Hip Hop 3
52	Hip Hop 4
53	Techno 1
54	Techno 2
55	Techno 3
56	Heavy Techno
57	8 Shuffle 1
58	8 Shuffle 2
59	8 Shuffle 3
60	Boogie
61	16 Shuffle 1
62	16 Shuffle 2
63	16 Shuffle 3
64	T Shuffle
65	Triplet 1
66	Triplet 2
67	Triplet 3
68	Triplet 4
69	Triplet Ballad 1
70	Triplet Ballad 2
71	Triplet Ballad 3
72	Motown 1
73	Motown 2
74	Ride Swing
75	H.H. Swing
76	Jazz Waltz 1
77	Jazz Waltz 2
78	5/4 Swing
79	Fast 4 Beat
80	H.H. Bossa Nova
81	Ride Bossa Nova
82	Beguine
83	Mambo
84	Cha Cha
85	Samba
86	Light Samba
87	Surdo Samba
88	Latin Groove
89	Afro Cuban
90	Songo
91	Bembe
92	Merenge
93	Reggae
94	Tango
95	Habanera
96	Waltz
97	Ragtime
98	Country & Western
99	March
100	6/8 March

Connecting to Other Devices

This instrument features a variety of jacks that allow the instrument to be connected to MIDI devices, computers, speakers, and mixers. It is also possible to connect external audio sources, such as an MP3 player, tablet, or a secondary keyboard, to the instrument's amplifier and speaker system. The illustration below provides a visual overview of the connectors and their typical applications.

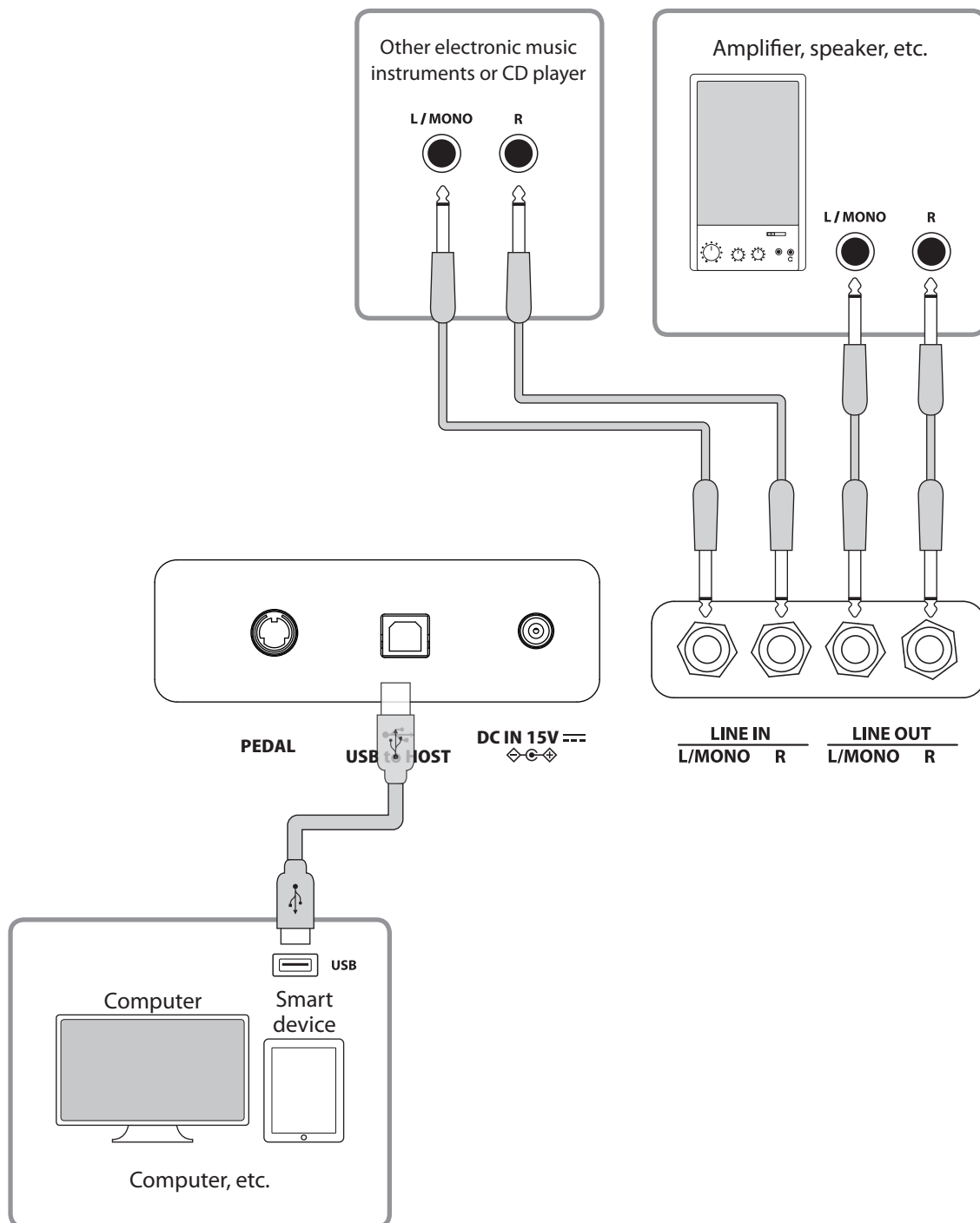

- Turn off this instrument before connecting to other devices.
- Do not connect LINE IN and LINE OUT on this instrument directly with a cable. A noise will occur and may result in a failure of the instrument.

■ USB drivers

For exchanging data between this digital piano and a computer via USB connection, the software (USB-MIDI driver) for the digital piano to function properly must be installed in the computer. On most modern operating systems, this driver software will be installed automatically, and additional drivers will not be required.

The USB-MIDI driver to use is different depending on the computer's operating system. For more information, please visit the Kawai Global website:

<https://www.kawai-global.com/support/manual>

■ Smart devices

This product supports connection to smart devices and allows players to use applications designed for the instrument.

Before using this feature, please check the latest information on the supported applications and operating environment, which is available from the Kawai Global website:

<https://www.kawai-global.com/support>

■ Notes on USB TO HOST

Bluetooth MIDI takes precedence if a Bluetooth MIDI device and a USB cable are connected at the same time.
When connecting the digital piano to a computer with a USB cable, insert the USB cable first and then turn on the digital piano.
After connecting the digital piano to a computer via USB, it may take some time to establish communication between them.
If communication becomes unstable on the connection between the digital piano and the computer through a USB hub, connect the USB cable directly to one of the computer's USB ports.
Powering on/off the digital piano or plugging/unplugging the USB cable during any of the following situations may cause the computer or digital piano to exhibit unstable behaviour: <ul style="list-style-type: none"> - while installing the driver - while restarting the computer - while the MIDI application is running - while communicating with the computer - while the computer is in energy-saver mode
Only connect USB memory devices to the [USB to Device] port. Connect the USB memory device directly, without using a USB extension cable.
Depending on the settings of the computer, the USB function may not work as intended. Please read the owner's manual of the computer and adjust the settings accordingly.

Assembly Instructions



The assembly requires two people.
When moving this product, make sure to keep it lifted in a horizontal orientation.
Be particularly careful to avoid catching hands and fingers in between parts.

Checking the included parts

Before attempting to assemble this product, ensure that all the parts listed below are included. Please also prepare a Phillips-head screwdriver.

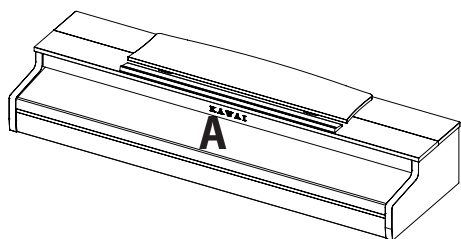

Main body

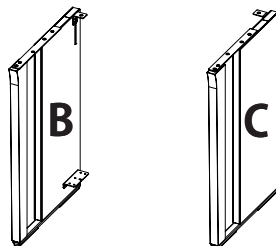

Side panels (left & right)

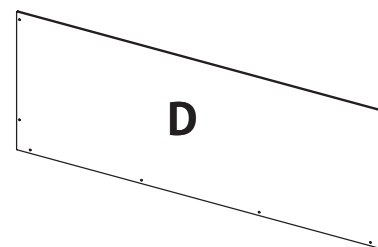

Back board

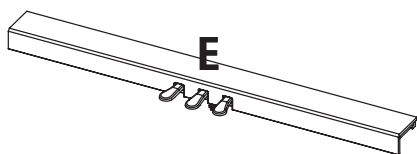

Pedal board
(including adjustor bolt)

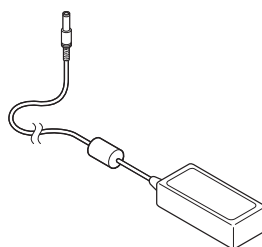

AC adaptor

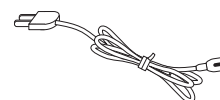

Power cord

Screw set

- a** Screw (with flat washer and spring washer) x 4



- b** Tapping screw (long, black) (4 x 30mm) x 4 *



- c** Tapping screw (short, black) (4 x 20mm) x 4 *



- d** Tapping screw (silver) (4 x 16mm) x 4

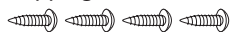

* **d** The silver tapping screws are provided in a separate bag.

* For some of the body colours, silver screws are provided instead of black screws.

Headphone hook set

Headphone hook Mounting screw (4 x 14 mm) x 2



1. Attaching B and C to E

- ① Unfasten the pedal cable attached to E (one location only) and extend the cable.
- ② Take the screws temporary mounted in E and set each one to the metal groove of B and C, respectively.
- ③ Make sure that B and C are pressed against E without a gap. Then, fasten the temporary mounting screws.
- ④ Insert the four silver tapping screws **d** into the rest of the holes. Tighten the screws to secure the panels in place.

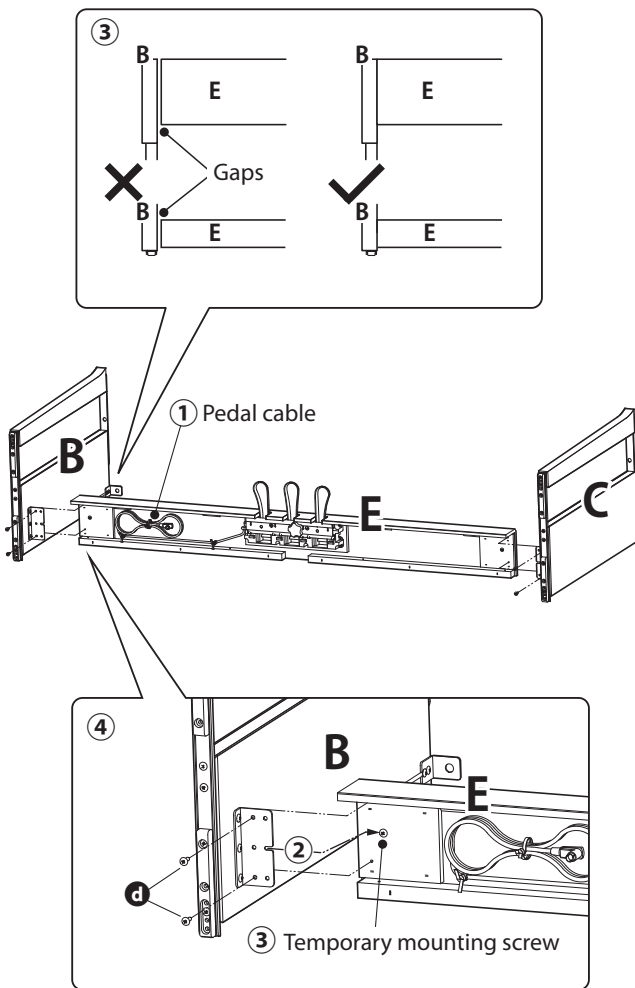

2. Attaching D

- ① Allow the E assembled with B and C to stand upright as shown in the figure below.
- Ensure that the adjuster is attached and the floor is clear from parts or musical scores etc..**
- ② Align the screw hole position of D to that of B and C. Use four pieces of the long black tapping screws **b** to set them in place temporarily.
- ③ Align the screw hole position of D and E. Use four pieces of the short black tapping screws **c** to secure them in place.
- ④ Ensure that B and C are aligned with D without a gap, and then fasten the temporarily mounted **b** long black tapping screws* to keep them in contact.

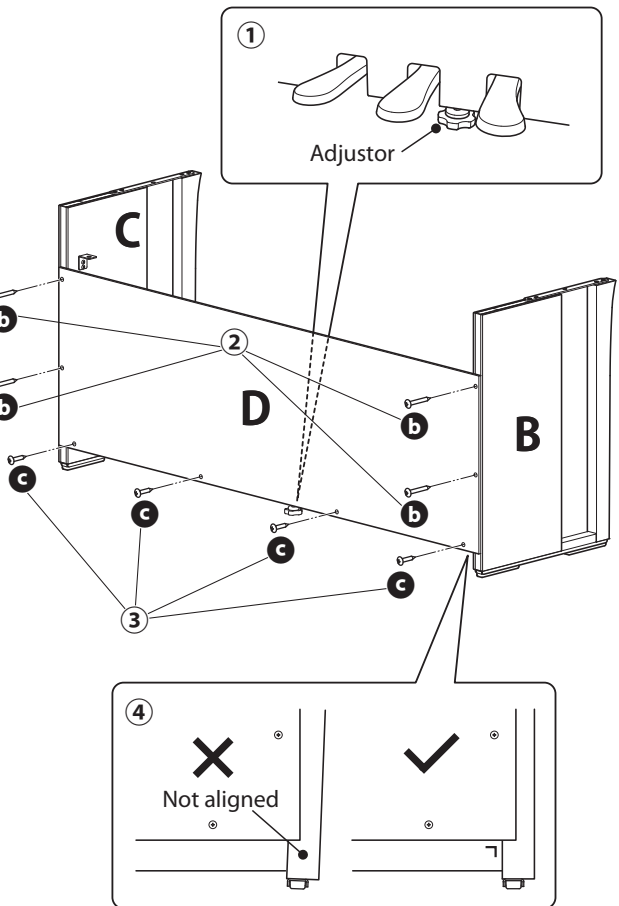

* For some of the body colours, silver screws are provided instead of black screws.

3. Mounting A onto the stand

- ① Lift A and carefully place it onto the stand. Position A so that the metal fitting holes are visible on the rear side of A when viewed from above.
- ② Secure C in place. To prevent A from tilting and falling off, hold the front side of A with one hand and slide A backwards. The hook of A engages the metal fitting of the side panel.



Be careful not to have hands or fingers caught between A and the stand.

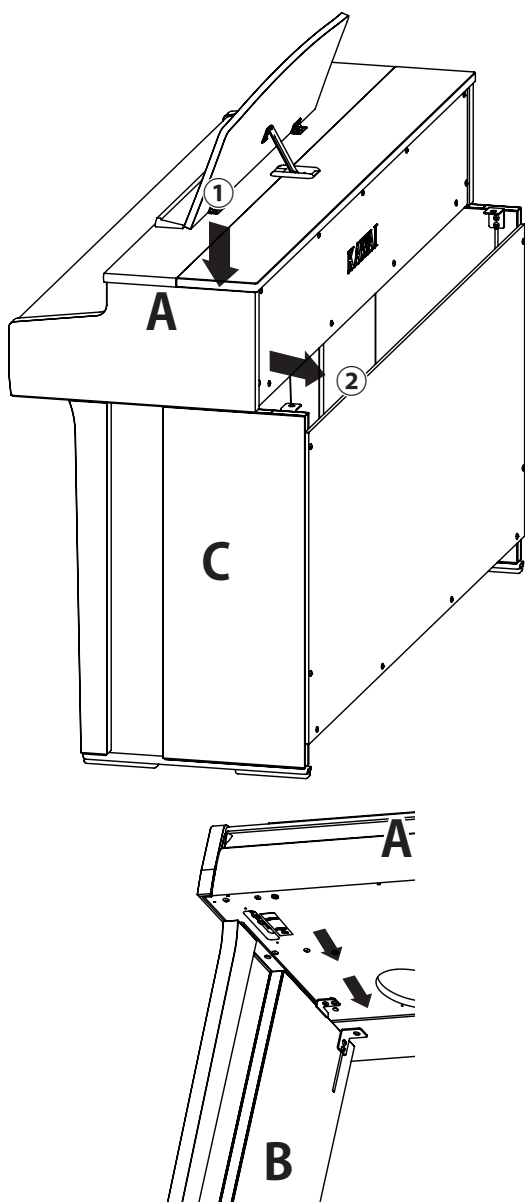

4. Fastening A to the stand

- ① Temporarily fasten A and the stand with four screws **a** (with flat washer and spring washer).
- ② First, loosely fasten the screws **a**, and move A to the position that allows the four screws go straight in. Then, even out the left and right overhang.
- ③ Lastly, tighten the temporarily fastened screws **a** until the spring washer becomes flat to ensure that A is rigidly attached to the stand.



Make sure to fasten A to the stand using the screws. Failure to do so could cause A to fall off from the stand, which is extremely dangerous.

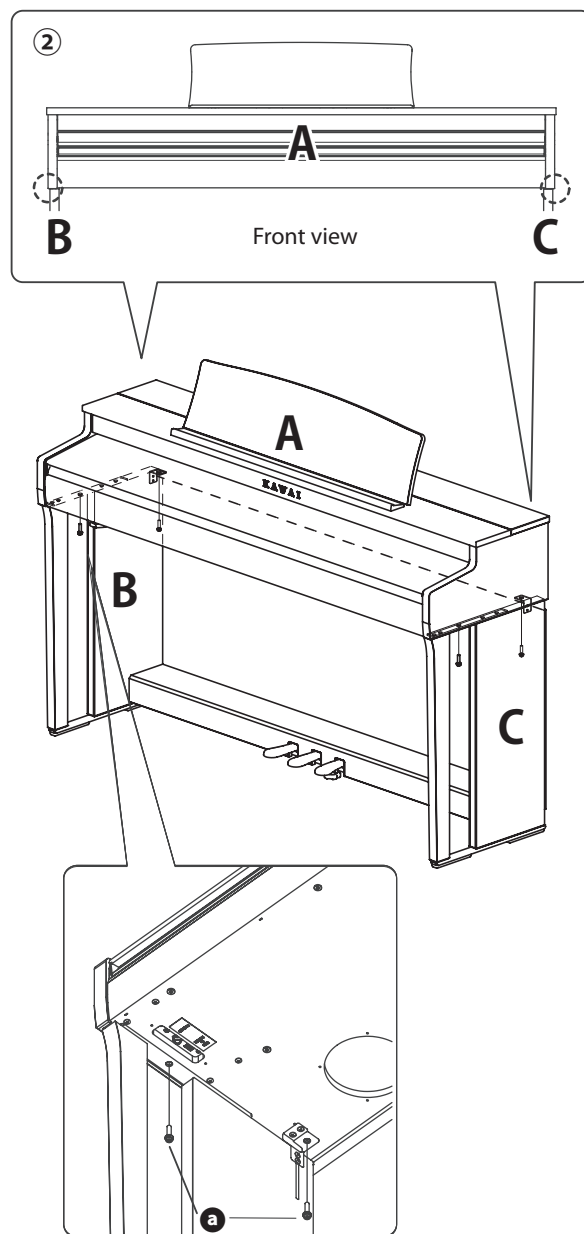

5. Connecting the cables

- ① Pass the pedal cable extended from E through the gap of D to the rear side of the instrument and insert the cable to the pedal connector on the bottom of A.
- ② Plug the AC adaptor into the power cord and insert it into the [DC IN] jack.
- ③ Use the binders to secure the cables connected to B.

!

- Be careful with the orientation of the connector parts.
- Plug the connector straight in. Forcibly inserting it could lead to a malfunction.

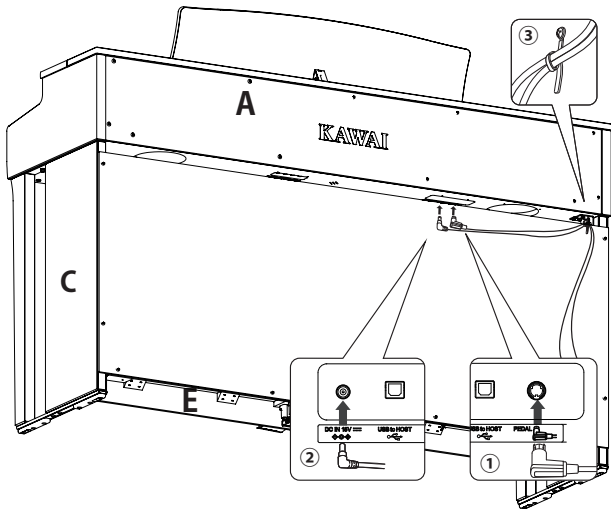

! Insert the plug straight in at the correct angle. Avoid applying excess force on it. Not doing so could bend the pins or damage the plugs.

Keep the correct angle Do not bend Do not pull the cable

6. Attaching the headphone hook

Attach the headphone hook to the hole shown in the figure, using the two tapping screws (4 x 14 mm) provided in the same bag.

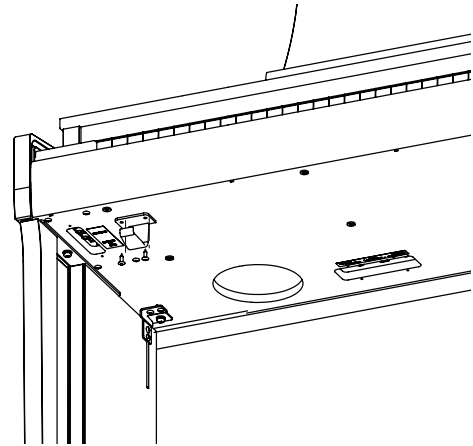

7. Rotating the adjustor

Make sure to rotate the adjustor on the rear side of E until the adjustor touches the floor. Depending on the material and condition of the floor, stepping on the pedal may generate frictional noises between the pedal and the floor. If this happens, please use a felt or carpet pad between the floor and the adjustor to fill the gap.

! Using the instrument with the adjustor lifted off the floor or forcibly pressed against the floor could cause the pedal base to break. When moving the instrument, make sure to lift it off from the floor without dragging it.

Information about Adaptor Specifications

This adapter specification table conforms to the requirements of EU Commission Regulation (EU) 2019/1782.

	Adaptor Type			
	PS-129	PS-154	PS-241	PS-242
Manufacturer's trademark	KAWAI	KAWAI	KAWAI	KAWAI
Model identifier	PS-129	PS-154	PS-241	PS-242
Input voltage	230 V	230 V	230 V	230 V
Input AC frequency	50 Hz	50 Hz	50 Hz	50 Hz
Output voltage	12.0 V	15.0 V	24.0 V	24.0 V
Output current	2.0 A	4.0 A	6.2 A	5.0 A
Output power	24.0 W	60.0 W	150.0 W	120.0 W
Average active efficiency	90.38%	90.17%	90.41%	91.55%
Efficiency at low load (10%)	85.71%	85.13%	78.62%	88.84%
No-load power consumption	0.061 W	0.200W	0.135 W	0.020 W

EU Declaration of Conformity

EU Declaration of Conformity

BG	ОПРОСТЕНА ЕС ДЕКЛАРАЦИЯ ЗА СЪОТВЕТСТВИЕ
Bulgarian	С настоящото Kawai Европа GmbH декларира, че този тип радиосъоръжение [CN301] е в съответствие с Директива 2014/53/ЕС. Цялостният текст на ЕС декларацията за съответствие може да се намери на следния интернет адрес:
ES	DECLARACIÓN UE DE CONFORMIDAD SIMPLIFICADA
Spanish	Por la presente, Kawai Europa GmbH declara que el tipo de equipo radioeléctrico [CN301] es conforme con la Directiva 2014/53/UE. El texto completo de la declaración UE de conformidad está disponible en la dirección Internet siguiente:
CS	ZJEDNODUŠENÉ EU PROHLÁŠENÍ O SHODĚ
Czech	Tímto Kawai Europa GmbH prohlašuje, že typ rádiového zařízení [CN301] je v souladu se směrnicí 2014/53/EU. Úplné znění EU prohlášení o shodě je k dispozici na této internetové adrese:
DA	FORENKLET EU-OVERENSSTEMMELSESEKKLÆRING
Danish	Hermed erklærer Kawai Europa GmbH, at radioustyrstypen [CN301] er i overensstemmelse med direktiv 2014/53/EU. EU-overensstemmelseserklæringens fulde tekst kan findes på følgende internetadresse:
DE	VEREINFACHTE EU-KONFORMITÄTSEKTLÄRUNG
German	Hiermit erklärt Kawai Europa GmbH, dass der Funkanlagentyp [CN301] der Richtlinie 2014/53/EU entspricht. Der vollständige Text der EU-Konformitätserklärung ist unter der folgenden Internetadresse
ET	LIHTIÖLÄTUSTATUD ELI VASTAVUSDEKLARATSIOON
Estonian	Käesolevaga deklareerib Kawai Europa GmbH, et käesolev raadioseadme tüüp [CN301] vastab direktiivi 2014/53/EL nõuetele. ELi vastavusdeklaratsiooni täielik tekst on kättesaadav järgmisel internetiaadressil:
EL	ΑΠΛΟΥΣΤΕΥΜΕΝΗ ΔΗΛΩΣΗ ΣΥΜΜΟΡΦΩΣΗΣ ΕΕ
Greek	Με την παρούσα ο/η Kawai Europa GmbH, δηλώνει ότι ο ραδιοεξοπλισμός [CN301] πληροί την οδηγία 2014/53/ΕΕ. Το πλήρες κείμενο της δήλωσης συμμόρφωσης ΕΕ διατίθεται στην ακόλουθη ιστοσελίδα στο διαδίκτυο:
EN	SIMPLIFIED EU DECLARATION OF CONFORMITY
English	Hereby, Kawai Europa GmbH declares that the radio equipment type [CN301] is in compliance with Directive 2014/53/EU. The full text of the EU declaration of conformity is available at the following internet address:
FR	DECLARATION UE DE CONFORMITE SIMPLIFIEE
French	Le soussigné, Kawai Europa GmbH, déclare que l'équipement radioélectrique du type [CN301] est conforme à la directive 2014/53/UE. Le texte complet de la déclaration UE de conformité est disponible à l'adresse internet suivante:
HR	POJEDNOSTAVLJENA EU IZJAVA O SUKLADNOSTI
Croatian	Kawai Europa GmbH ovime izjavljuje da je radijska oprema tipa [CN301] u skladu s Direktivom 2014/53/EU. Cjeloviti tekst EU izjave o sukladnosti dostupan je na sljedećoj internetskoj adresi:
IT	DICHIARAZIONE DI CONFORMITÀ UE SEMPLIFICATA
Italian	Il fabbricante, Kawai Europa GmbH, dichiara che il tipo di apparecchiatura radio [CN301] è conforme alla direttiva 2014/53/UE. Il testo completo della dichiarazione di conformità UE è disponibile al seguente indirizzo Internet:
LV	VIENKĀRŠOTA ES ATBILSTĪBAS DEKLARĀCIJA
Latvian	Ar šo Kawai Europa GmbH deklarē, ka radioiekārta [CN301] atbilst Direktīvai 2014/53/ES. Pilns ES atbilstības deklarācijas teksts ir pieejams šādā interneta vietnē:
LT	SUPAPRASTINTA ES ATITIKTIES DEKLARACIJA
Lithuanian	Aš, Kawai Europa GmbH, patvirtinu, kad radijo įrenginių tipas [CN301] atitinka Direktyvą 2014/53/ES. Visas ES atitikties deklaracijos tekstas prieinamas šiuo interneto adresu:
HU	EGYSZERŰSÍTETT EU-MEGFELELŐSÉGI NYILATKOZAT
Hungarian	Kawai Europa GmbH igazolja, hogy a [CN301] típusú rádióberendezés megfelel a 2014/53/EU irányelvnek. Az EU-megfelelőségi nyilatkozat teljes szövege elérhető a következő internetes címen:
MT	DIKJARAZZJONI SSIMPLIFIKATA TA' KONFORMITÀ TAL-UE
Maltese	B'dan, Kawai Europa GmbH, niddikjara li dan it-tip ta' tagħmir tar-radju [CN301] huwa konformi mad-Direttiva 2014/53/UE. It-test kollu tad-dikjarazzjoni ta' konformità tal-UE huwa disponibbli f'dan l-indirizz tal-Internet li ġej:
NL	VEREENVOUDIGDE EU-CONFORMITEITSVERKLARING
Dutch	Hierbij verklaar ik, Kawai Europa GmbH, dat het type radioapparatuur [CN301] conform is met Richtlijn 2014/53/EU. De volledige tekst van de EU-conformiteitsverklaring kan worden geraadpleegd op het volgende internetadres:
PL	UPROSZCZONA DEKLARACJA ZGODNOŚCI UE
Polish	Kawai Europa GmbH niniejszym oświadcza, że typ urządzenia radiowego [CN301] jest zgodny z dyrektywą 2014/53/UE. Pełny tekst deklaracji zgodności UE jest dostępny pod następującym adresem internetowym:
PT	DECLARAÇÃO UE DE CONFORMIDADE SIMPLIFICADA
Portuguese	O(a) abaixo assinado(a) Kawai Europa GmbH declara que o presente tipo de equipamento de rádio [CN301] está em conformidade com a Diretiva 2014/53/UE. O texto integral da declaração de conformidade está disponível no seguinte endereço de Internet:
RO	DECLARAȚIA UE DE CONFORMITATE SIMPLIFICATĂ
Romanian	Prin prezenta, Kawai Europa GmbH declară că tipul de echipamente radio [CN301] este în conformitate cu Directiva 2014/53/UE. Textul integral al declarației UE de conformitate este disponibil la următoarea adresă internet:
SK	ZJEDNODUŠENÉ EÚ VYHLÁSENIE O ZHODE
Slovak	Kawai Europa GmbH týmto vyhlasuje, že rádiové zariadenie typu [CN301] je v súlade so smernicou 2014/53/EÚ. Úplné EÚ vyhlásenie o zhode je k dispozícii na tejto internetovej adrese:
SL	POENOSTAVLJENA IZJAVA EU O SKLADNOSTI
Slovenian	Kawai Europa GmbH potrjuje, da je tip radijske opreme [CN301] skladen z Direktivo 2014/53/EU. Celotno besedilo izjave EU o skladnosti je na voljo na naslednjem spletnem naslovu:
FI	YKSINKERTAISTETTU EU-VAATIMUSTENMUKAISUUSVAKUUTUS
Finnish	Kawai Europa GmbH vakuuttaa, että radiolaitetyyppi [CN301] on direktiivin 2014/53/EU mukainen. EU-vaatimustenmukaisuusvakuutuksen täysimittainen teksti on saatavilla seuraavassa
SV	FÖRENKLAD EU-FÖRSÄKRAN OM ÖVERENSSTÄMMELSE
Swedish	Härmed försäkras Kawai Europa GmbH att denna typ av radioustrustning [CN301] överensstämmer med direktiv 2014/53/EU. Den fullständiga texten till EU-försäkran om överensstämmelse finns på följande webbadress:
https://www.kawai-global.com/	

Specifications

Keyboard	Responsive Hammer III (RHIII) action with Let-Off, Triple Sensor, and Counterweights 88 weighted keys with Ivory Touch key surfaces
Display	128 × 64 dots OLED
Polyphony	max. 256 notes
Sounds	45 sounds 
Metronome	1/4, 2/4, 3/4, 4/4, 5/4, 3/8, 6/8, 7/8, 9/8, 12/8 beat + 100 drum rhythms
Internal Recorder	10 song, 2 track recorder – approximately 90,000 note memory capacity
USB Recorder	Playing back: MP3 (bitrate: 8 to 320 kbit/s, sampling frequency: 44.1 kHz, 48 kHz, or 32 kHz), WAV (44.1 kHz, 16 bit), SMF, KSO (internal song file)
Internal Songs	Demo Songs: 33 songs Piano Music: 29 songs Concert Magic: 176 songs
Virtual Technician	Touch Curve, Voicing, Damper Resonance, Damper Noise, String Resonance, Undamped String Resonance, Cabinet Resonance, Key-off Effect, Fall-back Noise, Hammer Noise, Hammer Delay, Topboard Simulation, Decay Time, Release Time, Minimum Touch, Stretch Tuning/User Tuning, Temperament, Temperament Key, Key Volume, Half-Pedal Adjust, Soft Pedal Depth
Phones Settings	Spatial Headphone Sound (SHS), Phones Type, Phones Volume
Bluetooth®	MIDI: Bluetooth (Ver. 5.0 GATT-compatible) / Bluetooth Low Energy MIDI Specification-compliant AUDIO: Bluetooth (Ver. 5.1 A2DP-compatible)
Other Functions	Reverb, Effects, Dual, Split, Four Hands, Registration Memories, Panel Lock, Key Transpose, Song Transpose, Tone Control, Speaker Volume, Low Volume Balance, Tuning, Damper Hold, Startup Setting, Factory Reset, Auto Display Off, Auto Power Off, MIDI Settings, USB Menu
Pedals	Sustain (with half-pedal support), Soft (with half-pedal support), Sostenuto
Key Cover	Sliding type
Jacks	Headphones x 2 (1/4", 1/8"), LINE OUT (1/4" L/MONO, R), LINE IN (1/4" L/MONO, R) USB to Host, USB to Device
Output Power	20 W + 20 W
Speakers	13 cm x 2 (woofer) (8 x 12) cm x 2 (top speaker)
Power Consumption	17 W (154 AC adaptor)
Dimensions (Folding music rest)	1410 (W) × 435 (D) × 870 (H) mm 55 1/2" (W) × 17 1/8" (D) × 34 1/2" (H)
Weight	47.5 kg / 105 lbs.

* The specifications and included products are subject to change without notice for improvement purposes.

* Availability of Bluetooth function dependent on market location.

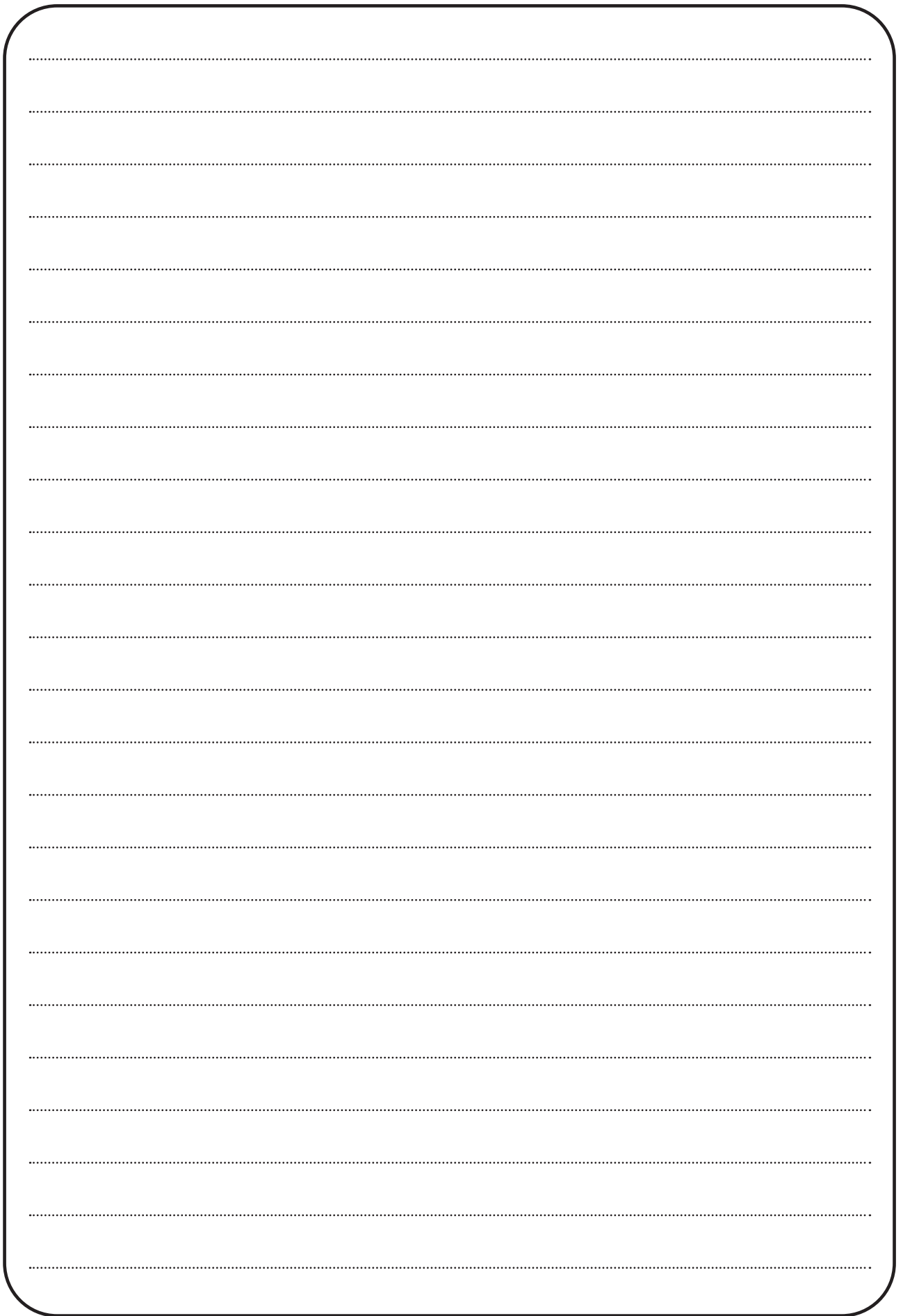

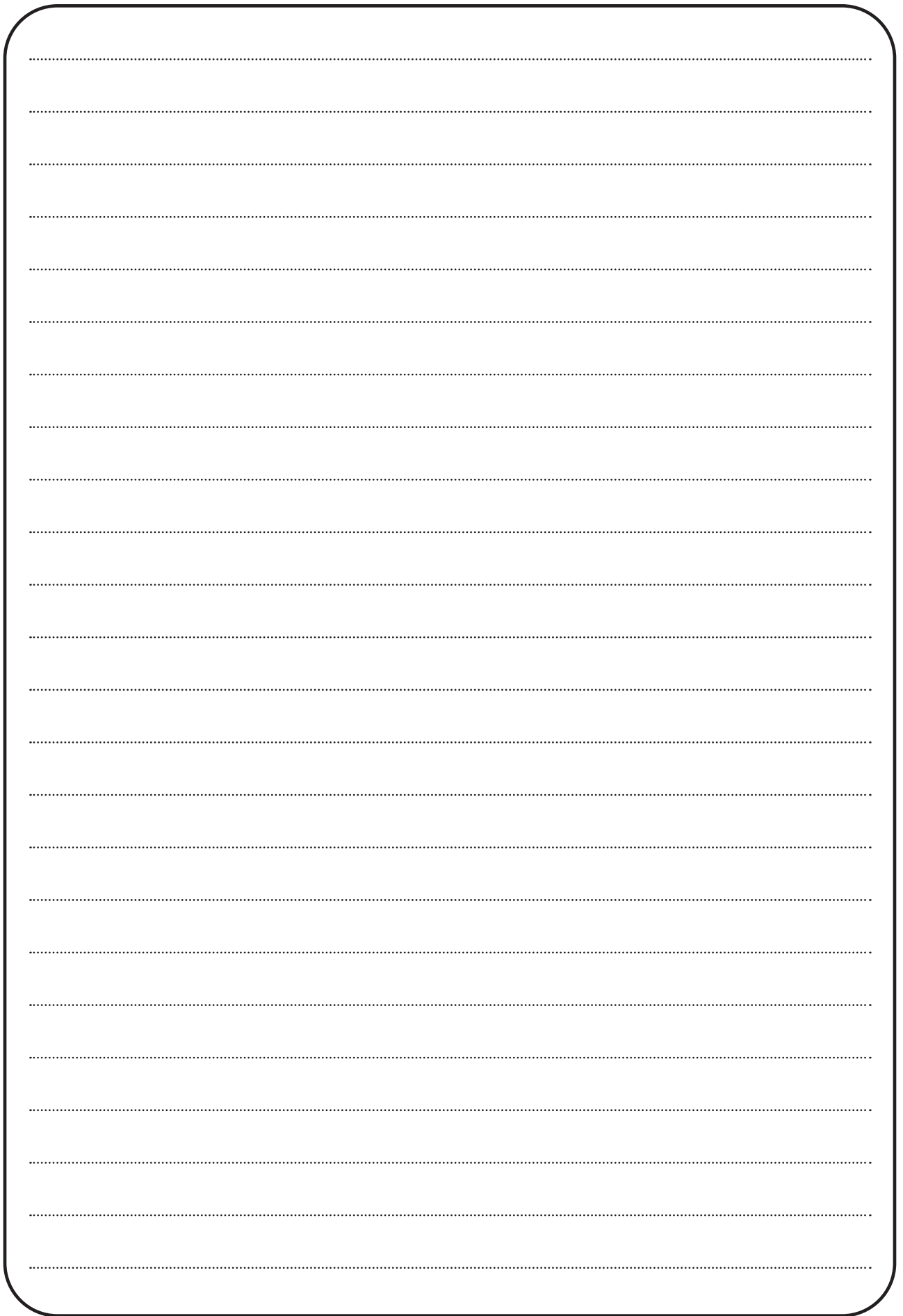

KAWAI
THE FUTURE OF THE PIANO